

A
GENERAL SKETCH
OF THE
EUROPEAN WAR

BY
HILAIRE BELLOS

THE FIRST PHASE

THOMAS NELS
LONDON, EDINBURGH, P

First published June 1, 1915

Reprinted June 1915

CONTENTS.

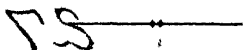

INTRODUCTION	7
------------------------	---

PART I.

THE GENERAL CAUSES OF THE WAR.

(1) THE GERMAN OBJECT	17
(2) CONFLICT PRODUCED BY THE CONTRAST OF THIS GERMAN ATTITUDE OR WILL WITH THE WILLS OF OTHER NATIONS	23
(3) PRUSSIA	27
(4) AUSTRIA	39
(5) THE PARTICULAR CAUSES OF THE WAR	50
(6) THE IMMEDIATE OCCASION OF THE WAR	64

PART II.

THE FORCES OPPOSED.

(1) THE GEOGRAPHICAL POSITION OF THE BELLIGERENTS	80
The Geographical Advantages and Disadvantages of the Germanic Body	86
The Geographical Advantages and Disadvantages of the Allies	121

CONTENTS.

(2) THE OPPOSING STRENGTHS	136
The Figures of the First Period, say to October 1-31, 1914	145
The Figures of the Second Period, say to April 15-June 1, 1915	151
(3) THE CONFLICTING THEORIES OF WAR	164

PART III.

THE FIRST OPERATIONS.

(1) THE BATTLE OF METZ	316
(2) LEMBERG	322
(3) TANNENBERG	345
(4) THE SPIRITS IN CONFLICT	365

INTRODUCTION.

IT is the object of this book, and those which will succeed it in the same series, to put before the reader the main lines of the European War as it proceeds. Each such part must necessarily be completed and issued some little time after the events to which it relates have passed into history. The present first, or introductory volume, which is a preface to the whole, covers no more than the outbreak of hostilities, and is chiefly concerned with an examination of the historical causes which produced the conflict, an estimate of the comparative strength of the various combatants, and a description of the first few days during which these combatants took up their positions and suffered the first great shocks of the campaigns in East and West.

But in order to serve as an introduction to the remainder of the series, it is neces-

sary that the plan upon which these books are to be constructed should be clearly explained.

There is no intention of giving in detail and with numerous exact maps the progress of the campaigns. Still less does the writer propose to examine disputed points of detail, or to enumerate the units employed over that vast field. His object is to make clear, as far as he is able, those great outlines of the business which too commonly escape the general reader.

This war is the largest and the weightiest historical incident which Europe has known for many centuries. It will surely determine the future of Europe, and in particular the future of this country. Yet the comprehension of its movements is difficult to any one not acquainted with the technical language and the special study of military history; and the reading of the telegrams day by day, even though it be accompanied by the criticisms of the military experts in the newspapers, leaves the mass of men with a most confused conception of what happened and why it happened.

Now, it is possible, by greatly simplify-

ing maps, by further simplifying these into clear diagrams, still more by emphasizing what is essential and by deliberately omitting a crowd of details—by showing first the framework, as it were, of any principal movement, and then completing that framework with the necessary furniture of analysed record—to give any one a conception both of what happened and of how it happened.

It is even possible, where the writer has seen the ground over which the battles have been fought (and much of it is familiar to the author of this), so to describe such ground to the reader that he will in some sort be able to see for himself the air and the view in which the things were done: thus more than through any other method will the things be made real to him. The aim, therefore, of these pages, and of those that will succeed them, is to give such a general idea of the campaigns as a whole as will permit whoever has grasped it a secure comprehension of the forces at work, and of the results of those forces. It is desired, for example, that the reader of these pages shall be able to say to himself: "The

Germanic body expected to win—and no wonder, for it had such and such advantages in number and in equipment. . . . The first two battles before Warsaw failed, and I can see why. It was because the difficulties in Russian supply were met by a contraction of the Russian line. . . . The 1st German Army was compelled to retreat before Paris, and I can now see why that was so: as it turned to envelop the Allied line, a great reserve within the fortified zone of Paris threatened it, and forced it back.”

These main lines, and these only, are attempted in the present book, and in those that are to follow it in this series.

The disadvantage of such a method is, of course, that the reader must look elsewhere for details, for the notices of a particular action, and the records of particular regiments. He must look for these to the large histories of the war, which will amply supply his curiosity in good time. But the advantage of the method consists in that it provides, as I hope, a foundation upon which all this bewildering multitude of detailed reading can repose.

I set out, then, to give, as it were, the

alphabet of the campaign, and I begin in this volume with the preliminaries to it—that is, its great political causes, deep rooted in the past; the particular and immediate causes which led to the outbreak of war; an estimate of the forces engaged; and the inception of hostilities.

PLAN OF THIS BOOK.

This first volume will cover three parts. In Part I. I shall write of The Causes of the War. In Part II. I shall Contrast the Forces Opposed. In Part III. (the briefest) I shall describe the First Shock.

In Part I., where I deal first with the general or historical causes of the war, later with the particulars, I shall:—

1. Define the German object which led up to it.
2. Show how this object conflicted with the wills of other nations.
3. Briefly sketch the rise of Prussia and of her domination over North Germany.
4. Define the position of Austria-Hungary in the matter, and thus close the general clauses.

5. The particular causes of the war will next be dealt with ; the curious challenge thrown down to Great Britain by the German Fleet *before* the German Empire had made secure its position on the Continent ; the French advance upon Morocco ; the coalition of the Balkan States against the remainder of the Turkish Empire in Europe.

6. Lastly, in this First Part, I shall describe the immediate occasion of the war and its surroundings : the ultimatum issued by the Austro-Hungarian Government to the little kingdom of Servia.

In Part II. I will attempt to present the forces opposed at the outbreak of war.

First, the contrast in the geographical position of the Germanic Allies with their enemies, the French, the English, and the Russians. Secondly, the numbers of trained men prepared and the numbers of reserves available in at least the first year to the various numbers in conflict. Thirdly, the way in which the various enemies had thought of the coming war (which was largely a matter of theory in the lack of experience) ; in what either party has been right, and in what wrong, as events

proved; and with what measure of foresight the various combatants entered the field.

In Part III. I will very briefly describe the original armed dispositions for combat at the outbreak of war, the German aim upon the West, and the German orders to the Austrians upon the East; the overrunning of Belgium, and the German success upon the Sambre; then the pursuit of the Franco-British forces to the line Paris-Verdun, up to the eve of the successful counter-offensive undertaken by them in the first week of September. I will end by describing what were the contemporary events in the Eastern field: in its northern part the overrunning of East Prussia by the Russians, and the heavy blow which the Germans there administered to the invader; in its southern the Austrian opposition to the Russians on the Galician borders, and the breakdown of that opposition at Lemberg.

My terminal date for this sketch will be the 5th of September.



A GENERAL SKETCH OF THE EUROPEAN WAR.

PART I.

THE GENERAL CAUSES OF THE WAR.

WAR is the attempt of two human groups each to impose its will upon the other by force of arms.

This definition holds of the most righteous war fought in self-defence as much as it does of the most iniquitous war of mere aggression. The aggressor, for instance, proposes to take the goods of his victim without the pretence of a claim. He is attempting to impose his will upon that victim. The victim, in resisting by force of arms, is no less attempting to impose his will upon the aggressor; and if he is victorious does effectually impose that will: for it is his will to prevent the robbery.

Every war, then, arises from some conflict of wills between two human groups, each intent upon some political or civic purpose, conflicting with that of his opponent.

War and all military action is but a means to a non-military end, to be achieved and realized in peace.

Although arguable differences invariably exist as to the right or wrong of either party in any war, yet the conflicting wills of the two parties, the irreconcilable political objects which each has put before itself and the opposition between which has led to conflict, can easily be defined.

They fall into two classes :—

1. The general objects at which the combatants have long been aiming.

2. The particular objects apparent just before, and actually provoking, the conflict.

In the case of the present enormous series of campaigns, which occupy the energies of nearly all Europe, the general causes can be easily defined, and that without serious fear of contradiction by the partisans of either side.

On the one hand, the Germanic peoples, especially that great majority of them now organized as the German Empire under

the hegemony of Prussia, had for fully a lifetime and more been possessed of a certain conception of themselves which may be not unjustly put into the form of the following declaration. It is a declaration consonant with most that has been written from the German standpoint during more than a generation, and many of its phrases are taken directly from the principal exponents of the German idea.

(I) THE GERMAN OBJECT.

“We the Germans are in spirit one nation. But we are a nation the unity of which has been constantly forbidden for centuries by a number of accidents. None the less that unity has always been an ideal underlying our lives. Once or twice in the remote past it has been nearly achieved, especially under the great German emperors of the Middle Ages. Whenever it has thus been nearly achieved, we Germans have easily proved ourselves the masters of other societies around us. Most unfortunately our very strength has proved our ruin time and again by leading us into adven-

tures, particularly adventures in Italy, which took the place of our national ideal for unity and disturbed and swamped it.

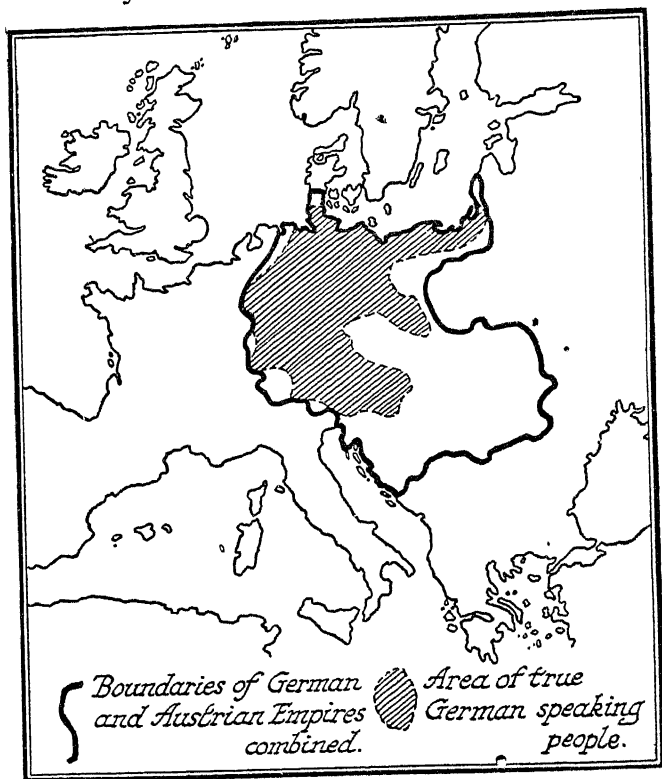

Sketch 1.

The reason we have been thus supreme whenever we were united or even nearly united lay in the fact, which must be

patent to every observer, that our mental, moral, and physical characteristics render us superior to all rivals. The German or Teutonic race can everywhere achieve, other things being equal, more than can any other race. Witness the conquest of the Roman Empire by German tribes; the political genius, commercial success, and final colonial expansion of the English, a Teutonic people; and the peculiar strength of the German races resident within their old homes on the Rhine, the Danube, the Weser, and the Elbe, whenever they were not fatally disunited by domestic quarrel or unwise foreign ideals. It was we who revived the declining society of Roman Gaul, and made it into the vigorous mediæval France that was ruled from the North. It was we who made and conquered the heathen Slavs threatening Europe from the East, and who civilized them so far as they could be civilized. We are, in a word, and that patently not only to ourselves but to all others, the superior and leading race of mankind; and you have but to contrast us with the unstable Celt—who has never produced a State—the corrupt and

now hopelessly mongrel Mediterranean or 'Latin' stock, the barbarous and disorderly Slav, to perceive at once the truth of all we say.

"It so happens that the various accidents which interrupted our strivings for unity permitted other national groups, inferior morally and physically to our own, to play a greater part than such an inferiority warranted; and the same accidents permitted men of Teutonic stock, not inhabiting the ancient homes of the Teutons, but emigrated therefrom and politically separated from the German Empire, to obtain advantages in which we ourselves should have had a share, but which we missed. Thus England, a Teutonic country, obtained her vast colonial empire while we had not a ship upon the sea.

"France, a nation then healthier than it is now, but still of much baser stock than our own, played for centuries the leading part in Western Europe; she is even to-day 'over-capitalized,' as it were, possessing a far greater hold over the modern world than her real strength warrants. Even the savage Slavs have profited by our former disunion, and the Russian autocracy

not only rules millions of German-speaking subjects, but threatens our frontiers with its great numbers of barbarians, and exercises over the Balkan Peninsula, and therefore over the all-important position of Constantinople, a power very dangerous to European culture as a whole, and particularly to our own culture—which is, of course, by far the highest culture of all.

“Some fifty years ago, acting upon the impulse of a group of great writers and thinkers, our statesmen at last achieved that German unity which had been the unrealized ideal of so many centuries. In a series of wars we accomplished that unity, and we amply manifested our superiority when we were once united by defeating with the greatest ease and in the most fundamental fashion the French, whom the rest of Europe then conceived to be the chief military power.

“From that moment we have incontestably stood in the sight of all as the strongest people in the world, and yet because other and lesser nations had the start of us, our actual international position, our foreign possessions, the security that should be due to so supreme an achievement, did not

correspond to our real strength and abilities. England had vast dependencies, and had staked out the unoccupied world as her colonies. We had no colonies and no dependencies. France, though decadent, was a menace to our peace upon the West. We could have achieved the thorough conquest and dismemberment of France at any time in the last forty years, and yet during the whole of that time France was adding to her foreign possessions in Tunis, Madagascar, and Tonkin, latterly in Morocco, while we were obtaining nothing. The barbarous Russians were increasing constantly in numbers, and somewhat perfecting their insufficient military machine without any interference from us, grave as was the menace from them upon our Eastern frontier.

“It was evident that such a state of things could not endure. A nation so united and so immensely strong could not remain in a position of artificial inferiority while lesser nations possessed advantages in no way corresponding to their real strength. The whole equilibrium of Europe was unstable through this contrast between what Germany might be and what she was, and

a struggle to make her what she might be from what she was could not be avoided.

“Germany must, in fulfilment of a duty to herself, obtain colonial possessions at the expense of France, obtain both colonial possessions and sea-power at the expense of England, and put an end, by campaigns perhaps defensive, but at any rate vigorous, to the menace of Slav barbarism upon the East. She was potentially, by her strength and her culture, the mistress of the modern world, the chief influence in it, and the rightful determinant of its destinies. She must by war pass from a potential position of this kind to an actual position of domination.”

Such was the German mood, such was the fatuous illusion which produced this war. It had at its service, as we shall see later, *numbers*, and, backed by this superiority of numbers, it counted on victory.

(2) CONFLICT PRODUCED BY THE CONTRAST OF THIS GERMAN ATTITUDE OR WILL WITH THE WILLS OF OTHER NATIONS.

When we have clearly grasped the German attitude, as it may thus be not un-

fairly expressed, we shall not find it difficult to conceive why a conflict between such a will and other wills around it broke out.

We need waste no time in proving the absurdity of the German assumptions, the bad history they involve, and the perverse and twisted perspective so much vanity presupposes. War can never be prevented by discovering the moral errors of an opponent. It comes into being because that opponent does not believe them to be moral errors; and in the attempt to understand this war and its causes, we should only confuse ourselves if we lost time over argument upon pretensions even as crassly unreal as these.

It must be enough for the purposes of this to accept the German will so stated, and to see how it necessarily conflicts with the English will, the French will, the Russian will, and sooner or later, for that matter, with every other national will in Europe.

In the matter of sea-power England would answer: "Unless we are all-powerful at sea, our very existence is imperilled." In the matter of her colonies and dependencies England would answer: "We may

be a Teutonic people or we may not. All that kind of thing is pleasant talk for the academies. But if you ask whether we will allow any part of our colonies to become German or any part of our great dependencies to fall under German rule, the answer is in the negative."

The French would answer: "We do not happen to think that we are either decadent or corrupt, nor do we plead guilty to any other of your vague and very pedantic charges; but quite apart from that, on the concrete point of whether we propose to be subjugated by a foreign Power, German or other, the answer is in the negative. Our will is here in conflict with yours. And before you can proceed to any act of mastery over us, you will have to fight. Moreover, we shall not put aside the duty of ultimately fighting you so long as a population of two millions, who feel themselves to be French (though most of them are German-speaking) and who detest your rule, are arbitrarily kept in subjection by you in Alsace-Lorraine."

The Russians would reply: "We cannot help being numerically stronger than you, and we do not propose to diminish

our numbers even if we could. We do not think we are barbaric; and as to our leadership of the Slav people in the Balkans, that seems as right and natural to us, particularly on religious grounds, as any such bond could be. It may interfere with your ambitions; but if you propose that we should abandon so obvious an attitude of leadership among the Slavs, the answer is in the negative." There is here, therefore, again a conflict of wills.

In general, what the German peoples desired, based upon what they believed themselves to be, was sharply at issue with what the English people, what the French people, what the Russian people respectively desired. Their desires were also based upon what *they* believed themselves to be, and they thought themselves to be very different from what Germany thought them to be. The English did not believe that they had sneaked their empire; the French did not believe that they were moribund; the Russians did not believe that they were savages.

It was impossible that the German will should impose itself without coming at

once into conflict with these other national wills. It was impossible that the German ideal should seek to realize itself without coming into conflict with the mere desire to live, let alone the self-respect, of everybody else.

And the consequence of such a conflict in ideals and wills translated into practice was this war.

But the war would not have come nor would it have taken the shape that it did, but for two other factors in the problem which we must next consider. These two other factors are, first, the position and tradition of Prussia among the German States; secondly, the peculiar authority exercised by the Imperial House of Hapsburg-Lorraine at Vienna over its singularly heterogeneous subjects.

(3) PRUSSIA.

The Germans have always been, during their long history, a race inclined to perpetual division and sub-division, accompanied by war and lesser forms of disagreement between the various sections.

Their friends have called this a love of freedom, their enemies political incompetence; but, without giving it a good or a bad name, the plain fact has been, century after century, that the various German tribes would not coalesce. Any one of them was always willing to take service with the Roman Empire, in the early Roman days, against any one of the others, and though there have been for short periods more or less successful attempts to form one nation of them all in imitation of the more civilized States to the west and south, these attempts have never succeeded for very long.

But it so happens that about two hundred years ago, or a little more, there appeared one body of German-speaking men rather different from the rest, and capable ultimately of leading the rest, or at least a majority of the rest.

I use the words "German-speaking" and "rather different" because this particular group of men, though speaking German, were of less pure German blood than almost any other of the peoples that spoke that tongue. They were the product of a conquest undertaken late in the

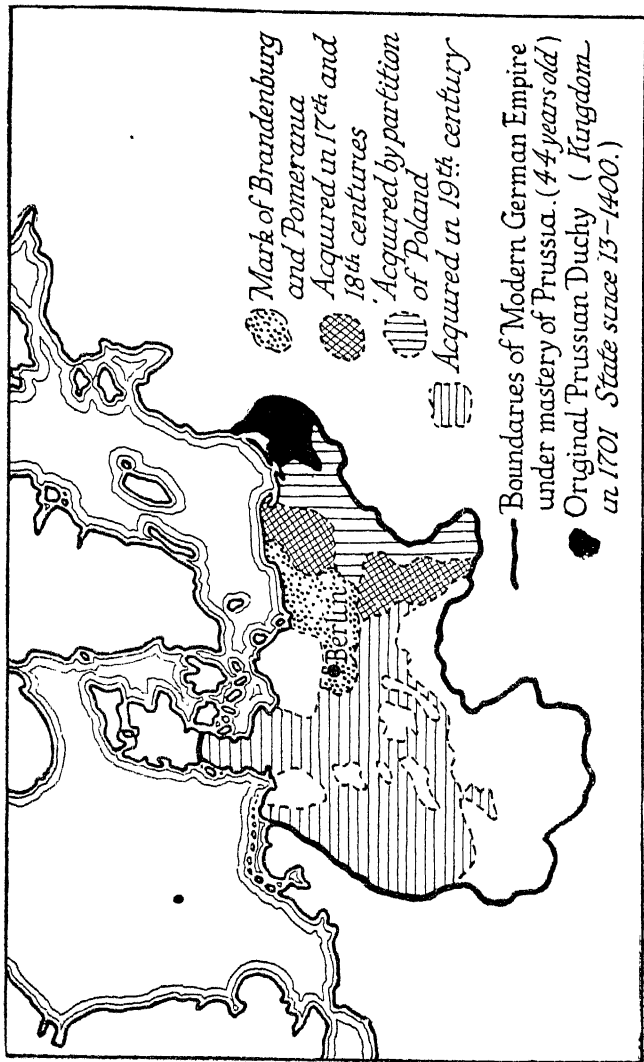

Sketch 2

Middle Ages by German knights over a mixed Pagan population, Lithuanian and Slavonic, which inhabited the heaths and forests along the Baltic Sea. These German knights succeeded in their task, and compelled the subject population to accept Christianity, just as the Germans themselves had been compelled to accept it by their more powerful and civilized neighbours the French hundreds of years before. The two populations of this East Baltic district, the large majority which was Slavonic and Lithuanian, and the minority which was really German, mixed and produced a third thing, which we now know as the *Prussian*. The cradle of this Prussian race was, then, all that flat country of which Königsberg and Danzig are the capitals, but especially Königsberg—"King's Town"—where the monarchs of this remote people were crowned. By an historical accident, which we need not consider, the same dynasty was, after it had lost all claim to separate kingship, merged in the rulers of the Mark of Brandenburg, a somewhat more German but still mixed district lying also in the Baltic plain, but

more towards the west, and the official title of the Prussian ruler somewhat more than two hundred years ago was the Elector of Brandenburg. These rulers of the Mark of Brandenburg were a family bearing the title of Hohenzollern, a castle in South Germany, by which name they are still distinguished. The palace of these Hohenzollerns was henceforward at Berlin.

Now, much at the same time that the civil wars were being fought in England—that is, not quite three hundred years ago—the Reformation had produced in Germany also very violent quarrels. Vienna, which was the seat of the Imperial House, stood for the Catholic or traditional cause, and most Germans adhered to that cause. But certain of the Northern German principalities and counties took up the side of the Reformation. A terrible war, known as the Thirty Years' War, was fought between the two factions. It enormously reduced the total population of Germany. • In the absence of exact figures we only have wild guesses, such as a loss of half or three-quarters. At any rate, both from losses from the adherence of many princes to the Protestant

cause and from the support lent to that cause for political reasons by Catholic France, this great civil war in Germany left the Protestant part more nearly equal in numbers to the Catholic part, and, among other things, it began to make the Elector of Brandenburg with his Prussians particularly prominent as the champion of the Protestant cause. For, of all the warring towns, counties, principalities, and the rest, Prussia had in particular shown military aptitude.

From that day to this the advance of Prussia as, first, the champion, then the leader, and at last the master of Northern Germany as a whole (including many Catholic parts in the centre and the south), has been consistent and almost uninterrupted. The "Great Elector" (as he was called) formed an admirable army some two hundred years ago. His grandson Frederick formed a still better one, and by his great capacities as a general, as well as by the excellence of his troops, gave Prussia a military reputation in the middle of the eighteenth century which has occasionally been eclipsed, but has never been extinguished.

Frederick the Great did more than this. He codified and gave expression, as it were, to the Prussian spirit, and the manifestation of that spirit in international affairs is generally called the "Frederician Tradition."

This "Frederician Tradition" must be closely noted by the reader, because it is the principal moral cause of the present war. It may be briefly and honestly put in the following terms:—

"The King of Prussia shall do all that may seem to advantage the kingdom of Prussia among the nations, notwithstanding any European conventions or any traditions of Christendom, or even any of those wider and more general conventions which govern the international conduct of other Christian peoples."

For instance, if a convention of international morals has arisen—as it did arise very strongly, and was kept until recent times—that hostilities should not begin without a formal declaration of war, the "Frederician Tradition" would go counter to this, and would say: "If ultimately it would be to the advantage of Prussia to attack without declaration

of war, then this convention may be neglected.”

Or, again, treaties solemnly ratified between two Governments are generally regarded as binding. And certainly a nation that never kept such a treaty for more than a week would find itself in a position where it was impossible to make any treaties at all. Still, if upon a vague calculation of men's memories, the acuteness of the circumstance, the advantage ultimately to follow, and so on, it be to the advantage of Prussia to break such solemn treaty, then such a treaty should be broken.

It will be apparent that what is called the “Frederician Tradition,” which is the soul of Prussia in her international relations, is not an unprincipled thing. It has a principle, and that principle is a patriotic desire to strengthen Prussia, which particular appetite overweighs all general human morals and far outweighs all special Christian or European morals.*

This doctrine of the “Frederician Tradition” does not mean that the Prussian statesmen wantonly do wrong, whether in acts of cruelty or in acts of treason and

bad faith. What it means is that, wherever they are met by the dilemma, " Shall I do *this*, which is to the advantage of my country but opposed to European and common morals, or *that*, which is consonant with those morals but to the disadvantage of my country?" they choose the former and not the latter course.

Prussia, endowed with this doctrine and possessed of a most excellent military organization and tradition, stood out as the first military power in Europe until the French Revolution. The wars of the French Revolution and of Napoleon upset this prestige, and in the battle of Jena (1806) seemed to have destroyed it. But it was too strong to be destroyed. The Prussian Government was the first of Napoleon's allies to betray Napoleon *after* the Russians had broken his power (1812). They took part with the other Allies in finishing off Napoleon after the Russian campaign (1813-14); they were present with decisive effect upon the final field of Waterloo (1815), and remained for fifty years afterwards the great military power they had always been. They had further added to their dominions such great areas in

Northern Germany, beyond the original areas inhabited by the true Prussian stock, that they were something like half of the whole Northern German people when, in 1864, they entered into the last phase of their dominion. They began by asking Austria to help them in taking from Denmark, a small and weak country, not only those provinces of hers which spoke German, but certain districts which were Danish as well. France and England were inclined to interfere, but they did not yet understand the menace Prussia might be in the future, and they neglected to act. Two years later Prussia suddenly turned upon Austria, her ally, defeated her in a very short campaign, and insisted upon Austria's relinquishing for the future all claims over any part of the German-speaking peoples, save some ten millions in the valley of the Middle Danube and of the Upper Elbe. Four years later again, in 1870, Prussia having arranged, after various political experiments which need not be here detailed, for the support of all the German States except Austria, fought a war with France, in which she was immediately and entirely successful, and in the course of

which the rulers of the other German States consented (1) to give the Hohenzollern-Prussian dynasty supreme military power for the future over them, under the hereditary title of German Emperors ; (2) to form a united nation under the more or less despotic power of these emperors.

This latter point, the national unity, though really highly centralized at Berlin, especially on the military side, was softened in its rigour by a number of very wise provisions. A great measure of autonomy was left to the more important of the lesser States, particularly Catholic Bavaria ; local customs were respected ; and, above all, local dynasties were flattered, and maintained in all the trappings of sovereign rank.

From that date—that is, for the last forty-four years—there has been a complete *Northern* Germany, one strong, centralized, and thoroughly co-ordinated nation, in which the original Prussian domination is not only numerically far the greatest element, but morally overshadows all the rest. The spiritual influence ruling this state issues from Berlin and from the Prussian soul, although a large minority consist of

contented but respectful Catholics, who, in all national matters, wholly sympathize with and take their cue from the Protestant North.

So far one may clearly see what kind of power it is that has initiated the German theory of supremacy which we have described above, is prepared to lead it to battle, and is quite certain of leading it to victory.

But we note—the fatal mark in all German history—that the unity is not complete. The ten millions of Austrian Germans were, when Prussia achieved this her highest ambition, deliberately left outside the new German Empire. And this was done because, in Prussian eyes, a so-called “German unity” was but a means to an end, and that end the aggrandizement of the Hohenzollern dynasty. To include so many southern and Catholic Germans would have endangered the mastery of Berlin. The fact that Austria ruled a number of non-German subjects far larger than her Austrian population would further have endangered the Hohenzollern position had Austria been admitted to the new German Empire, and had the

consolidation of all Germans into one true state been really and loyally attempted. Lastly, it would have been impossible to destroy the historic claims to leadership of the Imperial Hapsburgs, and that, more than anything else, was the rivalry the Hohenzollerns dreaded. Once more had the Germans proved themselves incapable of, and unwilling to submit to, the discipline of unity. What part, then, was Austria, thus left out, to play in the international activity of Prussia in the future? What part especially was she to play when Prussia, at the head of Northern Germany, should go out to impose the will of that Germany and of herself upon the rest of the world? That is the next question we must answer before we can hope to understand the causes of the present war in their entirety.

(4) AUSTRIA.

Austria, or, more strictly speaking, the Austro-Hungarian Empire, means no more than the congeries of States governed each separately and all in combination by the head of the House of Hapsburg-Lorraine. Of these various States only one is Ger-

man-speaking as a whole, and that is the Austrian State proper, the "Eastern States" (for that is what the word "Austria" originally meant) which Christendom erected round the Roman and Christian frontier town of Vienna to withstand the pressure of the heathen Slavs and Mongol Magyars surging against it upon this frontier.

The complexity of the various sections which make up the realm of the present Emperor Francis Joseph, the present head of the House of Hapsburg-Lorraine, would be only confusing if it were detailed in so general a description as this. We must be content with the broad lines of the thing, which are as follows :—

From the Upper Danube and its valley—all the basin of it, one may say, down to a point about twenty miles below Vienna—is the original Austrian State; German-speaking as a whole, and the historic centre of the entire agglomeration. East of this is the far larger state of Hungary, and Hungary is the valley of the river Danube, from where the German-speaking boundary cuts it, just below Vienna down to the Iron Gates, up to the

MODERN
GERMAN EMPIRE

● Patches of Italian speech
on the South
— Boundaries of Austro-
Hungarian Empire
- - - - Boundary of Hungary.

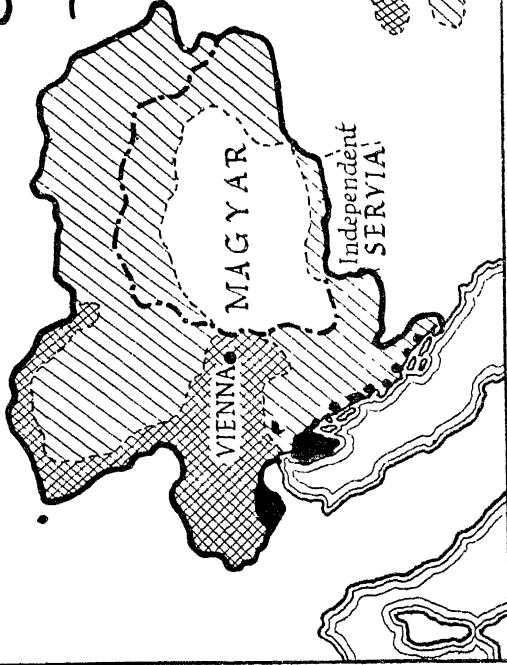

GERMAN SPEECH
Slav and Rumanian

Sketch 3.

crest of the Carpathians. These two great units of Austria proper and of Hungary have round them certain frills or edges. On the north are two great bodies, Slav in origin, Bohemia and Galicia; on the south another Slav body, separated from the rest for centuries by the eruption of the Magyars from Asia in the Dark Ages, and these Slav bodies are represented by Croatia, by much of Dalmatia, and latterly by Bosnia and Herzegovina, which have been governed by Austria for a generation, and formally annexed by her with the consent of Europe seven years ago. Finally, there is a strip, or, to be more accurate, there are patches of Italian-speaking people, all along the coasts of the Adriatic, and occupying the ports governed by Austria along the eastern and northern coast of that sea. There is also a belt of Alpine territory of Italian speech—the Trentino—still in Austrian hands.

This very general description gives, however, far too rough an idea of the extraordinarily complicated territories of the House of Hapsburg. Thus, there are considerable German-speaking colonies in Hungary, and these, oddly enough, are

more frequent in the east than in the west of that State. Again, the whole western slope of the Carpathians is, so far as the mass of the population is concerned, Roumanian in tongue, custom, and race. Bohemia, though Slavonic in origin, is regularly enframed along its four sides by belts of German-speaking people, and was mainly German-speaking until a comparatively recent revival of its native Slavonic tongue, the Czech. Again, though the Magyar language is Mongolian, like the Turkish, centuries of Christian and European admixture have left very little trace of the original race. Lastly, in all the north-eastern corner of this vast and heterogeneous territory, something like a quarter of the population is Jewish.

The Western student, faced with so extraordinary a puzzle of race and language, may well wonder what principle of unity there is lying behind it, and, indeed, this principle of unity is not easy to find.

Some have sought it in religion, pointing out that the overwhelming majority of these various populations are Catholic, in communion with Rome ; and, indeed, this Catholic tincture or colour has a great deal

to do with the Austro-Hungarian unity ; and of late years the chief directing policy of the House of Hapsburg-Lorraine has been to pose as the leader of the Catholic Slavs against the Slavs belonging to the Greek Church.

But this principle of unity is not the true one, for two reasons : first, that the motive leading the House of Hapsburg to the difficult task of so complicated a government is not a religious motive ; and, secondly, because this religious unity is subject to profound modification. Hungary, though Catholic in its majority, contains, and is largely governed by, powerful Protestant families, who are supported by considerable bodies of Protestant population. The Greek Church is the religious profession of great numbers along the Lower Danube valley and to the south of the river Save. There are in Bosnia a considerable number of Mahomedans even, and I have already mentioned the numerous Jewish population of the north-east, particularly in Galicia.

The true principle of unity in what has hitherto been the Austro-Hungarian Empire is twofold. It consists, first, in the reign-

ing family, considerable personal attachment to which is felt in every section of its dominions, utterly different as these are one from another ; and, secondly (a more important point), in the historical development of the State.

It is this last matter which explains all, and which can make us understand why a realm so astonishingly ill constructed was brought into the present struggle as one force, and that force a force allied to, and in a military sense identical with, modern Prussian Germany.

For the historical root of Austria-Hungary is German. Of its population (some fifty-one millions) you may say that only about a quarter are German-speaking (less than another quarter are Magyar-speaking, most of the rest Slavonic in speech, together with some proportion of Roumanian and Italian).

But it is from this German *quarter* and from the emperor at their head that the historical growth of the State depends, because this German *quarter* was the original Christian nucleus and the civilized centre, which had for its mission the reduction of Slavonic and Magyar barbarism.

The Slavs of the Bohemian quadrilateral were subjected, not indeed by conquest, but by a process of culture, to Vienna. The crown of Hungary, when it fell by marriage to the Hapsburgs, continued that tradition; and when the Empress Maria-Theresa, in the last century, participated in the abominable crime of Frederick the Great of Prussia, and took her share of the dismembered body of Poland (now called the Austrian province of Galicia), that enormous blunder was, in its turn, a German blunder undertaken under the example of Northern Germany, and as part of a movement German in spirit and origin. The same is true even of the very latest of the Austrian developments, the annexation of Bosnia and Herzegovina. The act was that of Vienna, but the spirit behind it, perhaps the suggestion of it, and the support that made it possible came from Berlin.

In a word, if you could interrogate the Genius of the Hapsburgs and ask it for what their dominion stood, it would tell you that for uninterrupted centuries they had stood for the German effort to repress or to overcome pressure upon the

German peoples from the East. And that is still their rôle. They have come into this war, for instance, as the servants of Prussia, not because Prussia threatened or overawed them, but because they felt they had, in common with Prussia, the mission of withstanding the Slav, or of tolerating the Slav only as a subject; because, that is, they feared, and were determined to resist, Russia, and the smaller Slavonic States, notably Servia to the south, which are in the retinue of Russia.

We may sum up, then, and say that the fundamental conflict of wills in Europe, which has produced this general war, is a conflict between the German will, organized by Prussia to overthrow the ancient Christian tradition of Europe (to *her* advantage directly; and indirectly, as she proposes, to the advantage of a supposedly necessary German governance of the world under Prussian organization), and the will of the more ancient and better founded Western and Latin tradition to which the sanctity of separate national units profoundly appeals, and a great deal more which is, in their eyes, civilization. In

this conflict, Prussia has called upon and received the support of not only the German Empire, which she controls, but also the Hapsburg monarchy, controlling the organized forces of Austria-Hungary; while there has appeared against this strange Prussian claim all that values the Christian tradition of Europe, and in particular the doctrine of national freedom, with very much else—which very much else are the things by which we of the civilized West and South, who have hitherto proved the creators of the European world, live and have our being. Allied with us, by the accident that this same German claim threatens them also, is the young new world of the Slavs.

It is at this final point of our examination that we may see the immensity of the issues upon which the war turns. The two parties are really fighting for their lives; that in Europe which is arrayed against the Germanic alliance would not care to live if it should fail to maintain itself against the threat of that alliance. It is for them life and death. On the other side, the Germans having propounded this theory of theirs, or rather

the Prussians having propounded it for them, there is no rest possible until they shall either have "made good" to our destruction, or shall have been so crushed that a recurrence of the menace from them will for the future be impossible.

There is here no possibility of such a "draw" or "stalemate" as was the result, for instance, of the reduction of Louis XIV.'s ambition, or of the great revolutionary effort throughout Europe which ended with the fall of Napoleon. Louis XIV.'s ambition cast over Europe, which received it favourably, the colour of French culture. The Revolutionary Wars were fought for a principle which, if it did not appeal universally to men, appealed at least to all those millions whose instincts were democratic in every country. But in this war there is no such common term. No one outside the districts led by Prussia desires a Prussian life, and perhaps most, certainly many, of those whom Prussia now leads are in different degrees unwilling to continue a Prussian life. The fight, in a word, is not like a fight with a man who, if he beats you, may make you sign away some property, or make you

acknowledge some principle to which you are already half inclined ; it is like a fight with a man who says, " So long as I have life left in me, I will make it my business to kill you." And fights of that kind can never reach a term less absolute than the destruction of offensive power in one side or the other. A peace not affirming complete victory in this great struggle could, of its nature, be no more than a truce.

So much for the really important and the chief thing which we have to understand—the general causes of the war.

Now let us turn to the particular causes. We shall find these to be, not like the general causes, great spiritual attitudes, but, as they always are, a sequence of restricted and recent *events*.

(5) THE PARTICULAR CAUSES OF THE WAR.

After the great victories of Prussia a generation ago (the spoliation of Denmark in 1864, the supremacy established over Austria in 1866, the crushing defeat of France and the annexation of Alsace-Lorraine, with two millions of people in

1870-1), Europe gradually drifted into being an armed camp, the great forces of which were more or less in equilibrium. Prussia had, for the moment at least, achieved all that she desired. The French were for quite twenty years ardently desirous of recovering what they had lost; but Europe would not allow the war to be renewed, and Prussia, now at the head of a newly constituted German Empire, made an arrangement with Austria and with Italy to curb the French desire for recovery. The French, obviously inferior before this triple alliance, gradually persuaded the Russians to support them; but the Russians would not support the French in provoking another great war, and with the French themselves the old feeling gradually deadened. It did not disappear—any incident might have revived it—but the anxious desire for immediate war when the opportunity should come got less and less, and at the end of the process, say towards 1904, when a new generation had grown up in all the countries concerned, there was a sort of deadlock, every one very heavily armed, the principal antagonists, France and Ger-

many, armed to their utmost, but the European States, as a whole, unwilling to allow any one of them to break the peace.

It was about this moment that Prussia committed what the future historian will regard, very probably, as the capital blunder in her long career of success. She began to build a great fleet. Here the reader should note two very important consequences of the great Prussian victories which had taken place a generation before. The first was the immense expansion of German industrialism. Germany, from an agricultural State, became a State largely occupied in mining, smelting, spinning, and shipbuilding; and there went with this revolution, as there always goes with modern industrialism, a large and unhealthy increase of population. The German Empire, after its war with France, was roughly equal to the population of the French; but the German Empire, after this successful industrial experiment, the result of its victories, was much more than half as large again in population as the French (68 to 39).

Secondly, the German Empire developed a new and very large maritime commerce.

This second thing did not follow, as some have imagined it does, from the first. Germany might have exported largely without exporting in her own ships. The creation of Germany's new mercantile marine was a deliberate part of the general Prussian policy of expansion. It was heavily subsidized, especially directed into the form of great international passenger lines, and carefully co-ordinated with the rest of the Prussian scheme throughout the world.

At a date determined by the same general policy, and somewhat subsequent to the first creation of this mercantile marine, came the decision to build a great fleet. Now, it so happens that Great Britain alone among the Powers of Europe depends for her existence upon supremacy at sea, and particularly upon naval superiority in the Narrow Seas to the east and the south of the British islands.

Such a necessity is, of course, a challenge to the rest of the world, and it would be ridiculous to expect the rest of the world to accept that challenge without protest. But a necessity this naval policy of Great Britain remains none the less.

The moment some rival or group of rivals can overcome her fleet, her mere physical livelihood is in peril. She cannot be certain of getting her food. She cannot be certain of getting those foreign materials the making up of which enables her to purchase her food. Further, her dominions are scattered oversea, and supremacy at sea is her only guarantee of retaining the various provinces of her dominion.

It is a case which has happened more than once before in the history of the world. Great commercial seafaring States have arisen; they have always had the same method of government by a small, wealthy class, the same ardent patriotism, the same scattered empire, and the same inexorable necessity of maintaining supremacy at sea. Only one Power had hitherto rendered this country anxious for the Narrow Seas: that Power was France, and it only controlled one-half of the two branches of the Narrow Seas, the North Sea and the Channel. It had been for generations a cardinal piece of English policy that the French Fleet should be watched, the English Fleet maintained overwhelmingly superior to it, and all opportunities for

keeping France engaged with other rivals used to the advantage of this country. On this account English policy leant, on the whole, towards the German side, during all the generation of rivalry between France and Germany which followed the war of 1870.

But when the Germans began to build their fleet, things changed. The Germans had openly given Europe to understand that they regarded Holland and Belgium, and particularly the port of Antwerp, as ultimately destined to fall under their rule or into their system. Their fleet was specifically designed for meeting the British Fleet; it corresponded to no existing considerable colonial empire, and though the development of German maritime commerce was an excuse for it, it was only an excuse. Indeed, the object of obtaining supremacy at sea was put forward fairly clearly by the promoters of the whole scheme. Great Britain was therefore constrained to transfer the weight of her support to Russia and to France, and to count on the whole as a force opposed, for the first time in hundreds of years, to North Germany in the international politics of Europe. Similarity of religion (which is a

great bond) and a supposed identity (and partly real similarity) of race were of no effect compared with this sentiment of necessity.

Here it is important to note that the transference of British support from one continental group to another neither produced aggression by Great Britain nor pointed to any intention of aggression. It is a plain matter of fact, which all future history will note, that the very necessity in English eyes of English supremacy at sea, and the knowledge that such a supremacy was inevitably a provocation to others, led to the greatest discretion in the use of British naval strength, and, in general, to a purely defensive and peaceful policy upon the part of the chief maritime power. It would, indeed, have been folly to have acted otherwise, for there was nothing to prevent the great nations, our rivals, if they had been directly menaced by the British superiority at sea, from beginning to build great fleets, equal or superior to our own. Germany alone pursued this policy, with no excuse save an obvious determination to undo the claim of the British Fleet.

I have called this a blunder, and, from the point of view of the German policy, it was a blunder. For if the Prussian dynasty set out, as it did, to make itself the chief power in the world, its obvious policy was to deal with its enemies in detail. It ought not, at any cost, to have quarrelled with Russia until it had finally disposed of France. If it was incapable, through lack of subtlety, to prevent the Franco-Russian group from forming, it should at least have made itself the master of that group before gratuitously provoking the rivalry of Great Britain. But "passion will have all now," and the supposedly cold and calculating nature of Prussian effort has about it something very crudely emotional, as the event has shown. From about ten years ago Prussian Germany had managed to array against itself not only the old Franco-Russian group but Great Britain as well.

This arrangement would not, however, have led to war. Equilibrium was still perfectly maintained, and the very strong feeling throughout all the great States of Europe that a disturbance of the peace would mean some terrible catastrophe, to

be avoided at all costs, was as powerful as ever.

The true origin of disturbance, the first overt act upon which you can put your finger and say, "Here the chain of particular causes leading to the great war begins," was the revolution in Turkey. This revolution took place in the year 1908, and put more or less permanently into power at Constantinople a group of men based upon Masonic influence, largely Western in training, largely composed of Jewish elements, known as the "Young Turks."

The first result of this revolution, followed as it inevitably was by the temporary weakening in international power which accompanies all civil war at its outset, was the declaration by Austria that she would regard the provinces of Bosnia and Herzegovina—hitherto only administered by her and nominally still Turkish—as her own territory.

It was but a formal act, but it proved of vast consequence. It was an open declaration by a Germanic Power that the hopes of the Servians, the main population of the district and a Slav nation closely

bound to Russia in feeling, were at an end ; that Servia must content herself with such free territory as she had, and give up all hope of a completely independent State uniting all Servians within its borders. It was as though Austria had said, " I intend in future to be the great European Power in the Balkans, Slav though the Balkans are, and I challenge Russia to prevent me." The Russian Government, thus challenged, would perhaps have taken the occasion to make war had not the French given it to be understood that they would not imperil European peace for such an object. The Prussian Government of the German Empire had, in all this crisis, acted perhaps as the leader, certainly as the protector and supporter of Austria ; and when France thus refused to fight, and Russia in turn gave way, the whole thing was regarded, not only in Germany but throughout the world, as equivalent to an armed victory. Observers whose judgment and criticism are of weight, even in the eyes of trained international agents, proclaimed what had happened to be as much a Prussian success as though the Prussian and Austrian armies

had met in the field and had defeated the Russian and the French forces.

The next step in this series was a challenge advanced by Germany against that arrangement whereby Morocco, joining as it did to French North Africa, should be abandoned to French influence, so far as England was concerned, in exchange for the French giving up certain rights of interference they had in the English administration of Egypt, and one or two other minor points. Germany, advancing from a victorious position acquired over the Bosnian business, affirmed (in the year 1911) her right to be consulted over the Moroccan settlement. Nor were the French permitted to occupy Morocco until they had ceded to Germany a portion of their African colony of the Congo. This transaction was confused by many side issues. German patriots did not regard it as a sufficient success, though French patriots certainly regarded it as a grave humiliation. But perhaps the chief consequence of the whole affair was the recrudescence in the French people as a whole of a temper, half forgotten, which provoked them to withstand the now

greatly increased power of the German Empire and of its ally, and to determine that if such challenges were to continue unchecked during the coming years, the national position of France would be forfeited.

Following upon this crisis came, in the next year—still a consequence of the Turkish Revolution—the sudden determination of the Balkan States, including Greece, to attack Turkey. It was the King of Montenegro (a small Slav State which had always maintained its independence) who fired the first shot upon the 8th of October, 1912, with his own hand. In the course of that autumn the Balkan Allies were universally successful, failed only in taking Constantinople itself, reduced Turkey in Europe to an insignificant strip of territory near the capital itself, and proceeded to settle the conquered territory according to an agreement made by them before the outbreak of hostilities.

But here the Germanic Powers again intervened.* The defeated Turkish Army had been trained by German officers upon a German system; the expansion of German and Austrian political military influence throughout the Near East was a

cardinal part of the German creed and policy. Through Austria the Balkans were to be dominated at last, and Austria, at this critical moment, vetoed the rational settlement which the allied Balkan States had agreed to among themselves. She would not allow the Servians to annex those territories inhabited by men of their race, and to reach their natural outlet to the sea upon the shores of the Adriatic. She proposed the creation of a novel State of Albania under a German prince, to block Serbia's way to the sea. She further proposed to Serbia compensation by way of Serbia's annexing the territory round Monastir, which had a Bulgarian population, and to Bulgaria the insufficient compensation of taking over, farther to the east, territory that was not Bulgarian at all, but mixed Greek and Turkish.

The whole thing was characteristically German in type, ignoring and despising national feeling and national right, creating artificial boundaries, and flagrantly sinning against the European sense of patriotism. A furious conflict between the various members of the former Balkan Alliance followed ; but the settlement which Austria

had virtually imposed remained firm, and the third of the great Germanic steps affirming the growing Germanic scheme in Europe had been taken.

But it had been taken at the expense of further and very gravely shaking the already unstable armed equilibrium of Europe.

The German Empire foresaw the coming strain ; a law was passed immediately increasing the numbers of men to be trained to arms within its boundaries, and ultimately increasing that number so largely as to give to Germany alone a very heavy preponderance—a preponderance of something like thirty per cent.—over the corresponding number trained in France.

To this move France could not reply by increasing her armed forces, because she already took every available man. She did the only possible thing under the circumstances. She increased by fifty per cent. the term during which her young men must serve in the army, changing that term from two years to three.

The heavy burden thus suddenly imposed upon the French led to very considerable political disputes in that country, especially as the parliamentary form of

government there established is exceedingly unpopular, and the politicians who live by it generally despised. When, therefore, the elections of last year were at hand, it seemed as though this French increase of military power would be in jeopardy. Luckily it was maintained, in spite of the opposition of fairly honest but uncritical men like Jaurés, and of far less reputable professional politicians.

Whether this novel strain upon the French people could have been long continued we shall never know, for, in the heat of the debates provoked by this measure and its maintenance, came the last events which determined the great catastrophe.

(6) THE IMMEDIATE OCCASION OF THE WAR.

We have seen how constantly and successfully Austria had supported the general Prussian thesis in Europe, and, in particular, the predominance of the German Powers over the Slav.

We have seen how, in pursuit of this policy, the sharpest friction was always suffered at the danger-point of *Servia*. *Servia* was the Slav State millions of

whose native population were governed against their will by Austro-Hungarian officials. Serbia was the Slav State mortally wounded by the annexation of Bosnia and Herzegovina. And Serbia was the Slav State which Austria had in particular mortified by forbidding her access to the Adriatic, and by imposing upon her an unnatural boundary, even after her great victories of the Balkan War.

The heir to the Hapsburgs—the man who, seeing the great age of his uncle, might at any moment ascend the throne—was the Archduke Francis. He had for years pursued one consistent policy for the aggrandizement of his House, which policy was the pitting of the Catholic Slavs against the Orthodox Slavs, thereby rendering himself in person particularly odious to the Orthodox Serbs, so many of whose compatriots and co-religionists were autocratically governed against their will in the newly annexed provinces.

To the capital of these provinces, Sarajevo, he proceeded in state in the latter part of last June, and there, through the emissaries of certain secret societies (themselves Austrian subjects, but cer-

tainly connected with the population of independent Servia, and, as some claimed, not unconnected with the Servian Government itself), he was assassinated upon Saturday, the 28th of June, 1914.

For exactly a month, the consequences of this event—the provocation which it implied to Austria, the opportunity which it gave the Hapsburgs for a new and more formidable expression of Germanic power against the Slavs—were kept wholly underground. *That is the most remarkable of all the preliminaries to the war.* There was a month of silence after so enormous a moment. Why? In order to give Germany and Austria a start in the conflict already long designed. Military measures were being taken secretly, stores of ammunition overhauled, and all done that should be necessary for a war which was premeditated in Berlin, half-feared, half-desired in Vienna, and dated for the end of July—after the harvest.

The Government of Berlin was, during the whole of this period, actively engaged in forcing Austria forward in a path to which she was not unwilling; and, at last, upon the 23rd of July, Europe was amazed

to read a note sent by the Imperial Governor at Vienna to the Royal Government in the Servian capital of Belgrade, which note was of a kind altogether unknown hitherto in the relations between Christian States. This note demanded not only the suppression of patriotic, and therefore anti-Austrian, societies in Servia (the assassins of the Crown Prince had been, as I have said, not Servian but Austrian subjects), but the public humiliation of the Servian Government by an apology, and even an issue of the order of the day to the Servian Army, so recently victorious, abasing that army to the worst humiliation. The note insisted upon a specific pledge that the Servian Government should renounce all hope of freeing the Servian nation as a whole from foreign government, and in many another clause subjected this small nation to the most thorough degradation ever suggested by a powerful European people towards a lesser neighbour.

So far, though an extreme hitherto unknown in European history had been reached, the matter was one of degree. Things of the same sort, less drastic, had been known in the past.

But what was novel in the note, and what undoubtedly proceeded from the suggestion of the Prussian Government (which was in all this the real agent behind Austria), *was the claim of the Austrian Government to impose its own magistrates upon the Servian courts, and to condemn at will those subjects of the Servian king and those officers holding his commission whom Austria might select so to condemn, and that to penalties at the goodwill and pleasure of Austria alone.* In other words, Austria claimed full rights of sovereignty within the territory of her small neighbour and enemy, and the acceptance of the note by Servia meant not only the preponderance of Austria for the future over the Slavs of the Balkans, but her continued and direct power over that region in the teeth of national and religious sentiment, and in clean despite of Russia.

So strong was the feeling still throughout Europe in favour of maintaining peace and of avoiding the awful crash of our whole international system that Russia advised Servia to give way, and the Germanic Powers were on the eve of yet another great success, far more important and enduring than anything they had yet

achieved. The only reservation which Serbia was permitted by the peaceful Powers of Europe, and in particular by Russia, to make was that, upon three points which directly concerned her sovereignty, Austria should admit the decision of a Court of Arbitration at the Hague. But the time-limit imposed—which was the extraordinarily short one of forty-eight hours—was maintained by Austria, and upon the advice, as we now know, of Berlin, no modification whatever in the demands was tolerated. Upon the 25th, therefore, the Austrian Minister left Belgrade. There followed ten days, the exact sequence of events in which must be carefully noted if we are to obtain a clear view of the origin of the war.

Upon that same day, Saturday, July 25th, the English Foreign Office, through Sir Edward Grey, suggested a scheme whereby the approaching cataclysm (for Russia was apparently determined to support Serbia) might be averted. He proposed that all operations should be suspended while the Ambassadors of Germany, Italy, and France consulted with him in London.

What happened upon the next day, Sun-

day, is exceedingly important. The German Government refused to accept the idea of such a conference, but at the same time the German Ambassador in London, Prince Lichnowski, was instructed to say that the principle of such a conference, or at least of mediation by the four Powers, was agreeable to Berlin. *The meaning of this double move was that the German Government would do everything it could to retard the entry into the business of the Western Powers, but would do nothing to prevent Russia, Servia, and the Slav civilization as a whole from suffering final humiliation or war.*

That game was played by Germany clumsily enough for nearly a full week. Austria declared war upon Servia upon Monday the 27th; but we now know that her intention of meeting Russia halfway, when she saw that Russia would not retire, was stopped by the direct intervention of the Prussian Government. In public the German Foreign Office still pretended that it was seeking some way out of the crisis. In private it prevented Austria from giving way an inch from her extraordinary demands. And all the while

Germany was secretly making her first preparations for war.

It might conceivably be argued by a special pleader that war was not the only intention of Berlin, as most undoubtedly it had not been the only intention of Vienna. Such a plea would be false, but one can imagine its being advanced. What is not capable even of discussion is the fact that both the Germanic Powers, under the unquestioned supremacy of Prussia, *were* determined to push Russia into the dilemma between an impossible humiliation and defeat in the field. They allowed for the possibility that she would prefer humiliation, because they believed it barely possible (though all was ready for the invasion of France at a moment already fixed) that the French would again fail to support their ally. But war was fixed, and its date was fixed, with Russia, or even with Russia and France, and the Germanic Powers arranged to be ready before their enemies. In order to effect this it was necessary to deceive the West at least into believing that war could after all be avoided.

One last incident betrays in the clearest manner how thoroughly Prussia had deter-

mined on war, and on a war to break out at her own chosen moment. It was as follows :

As late as Thursday, the 30th of July, Austria was still willing to continue a discussion with Russia. The Austrian Government on that day expressed itself as willing to reopen negotiations with Russia. The German Ambassador at Vienna got wind of this. He communicated it at once to Berlin. *Germany immediately stopped any compromise, by framing that very night and presenting upon the next day, Friday the 31st, an ultimatum to Russia and to France.*

Now, the form of these two ultimata and the events connected with them are again to be carefully noted, for they further illuminate us upon the German plan. That to Russia, presented by the German Ambassador Portales, had been prepared presupposing the just possible humiliation and giving way of Russia ; and all those who observed this man's attitude and manner upon discovering that Russia would indeed fight rather than suffer the proposed humiliation, agreed that it was the attitude and manner of an anxious man. The ultimatum to France had, upon the con-

trary, not the marks of coercion, but of unexpected and violent haste. If Russia was really going to fight, what could Prussia be sure of in the West? It was the second great and crude blunder of Prussian diplomacy that, instead of making any efforts to detach France from Russia, it first took the abandonment of Russia by France for granted, and then, with extreme precipitancy, asked within the least possible delay whether France would fight. That precipitancy alone lent to the demand a form which ensured the exact opposite of what Prussia desired.

This double misconception of the effect of her diplomatic action dates, I say, from Friday, the 31st of July, and that day is the true opening day of the great war. Upon Sunday, the 2nd of August, the German army violated the neutrality of Luxembourg, seizing the railway passing through that State into France, and pouring into its neutral territory her covering troops. On the same day, the French general mobilization was ordered; the French military authorities having lost, through the double action of Germany, about five days out of, say, eleven—nearly half the mobilization

margin—by which space of time German preparations were now ahead of theirs.

There followed, before the action state of general European conflict, the third German blunder, perhaps the most momentous, and certainly the most extraordinary: that by which Germany secured the hitherto exceedingly uncertain intervention of England against herself.

Of all the great Powers involved, Great Britain had most doubtfully to consider whether she should or should not enter the field.

On the one hand, she was in moral agreement with Russia and France; on the other hand, she was bound to them by no direct alliance, and successive British Governments had, for ten years past, repeatedly emphasized the fact that England was free to act or not to act with France according as circumstances might decide her.

Many have criticized the hesitation, or long weighing of circumstance, which astonished us all in the politicians during these few days, but no one, whether friendly to or critical of a policy of neutrality, can doubt that such a policy was not only a possible but a probable one.

The Parliamentarians were not unanimous, the opposition to the great responsibility of war was weighty, numerous, and strong. The financiers, who are in many things the real masters of our politicians, were all for standing out. In the face of such a position, in the crisis of so tremendous an issue, Germany, instead of acting as best she could to secure the neutrality of Great Britain, simply took that neutrality for granted !

Upon one specific point a specific question was asked of her Government. To Great Britain, as we have seen in these pages, the keeping from the North Sea coast of all great hostile Powers is a vital thing. The navigable Scheldt, Antwerp, the approaches to the Straits of Dover, are, and have been since the rise of British sea-power, either in the hands of a small State or innocuous to us through treaty. To-day they are the possession of Belgium, an independent State erected by treaty after the great war, and neutralized by a further guarantee in 1839. This neutrality of Belgium had been guaranteed in a solemn treaty not only by France and England, but by Prussia herself ; and the

British Government put to the French and to the Germans alike the question whether (now they were at war) that neutrality would be respected. The French replied in the affirmative; the Germans, virtually, in the negative. But it must not be said that this violation of international law and of her own word by Germany automatically caused war with England.

The German Ambassador was not told that if Belgian territory was violated England would fight; he was only told that if that territory were violated England might fight.

The Sunday passed without a decision. On Monday the point was, as a matter of form, laid before Parliament, though the House of Commons has no longer any real control over great national issues. In a speech which certainly inclined towards English participation in the war should Germany invade Belgium, the Secretary for Foreign Affairs summed up the situation before a very full House.

In the debate that followed many, and even passionate, speeches were delivered opposing the presence of England in the field and claiming neutrality. Some of these speeches insisted upon the admiration

felt by the speaker for modern Germany and Prussia ; others the ill judgment of running the enormous risk involved in such a campaign. These protests will be of interest to history, but the House of Commons as a whole had, of course, no power in the matter, and sat only to register the decisions of its superiors. There was in the Cabinet resignation of two members, in the Ministry the resignation of a third, the threatened resignation of many more.

Meanwhile, upon that same day, August 3rd, following with superstitious exactitude the very hour upon which, on the very same day, the French frontier had been crossed in 1870, the Germans entered Belgian territory.

The Foreign Office's thesis underlying the declaration of its spokesman, Sir Edward Grey, carried the day with the politicians in power, and upon Tuesday, August 4th, Great Britain joined Russia and France, at war with the Prussian Power. There followed later the formal declaration of war by France as by England against Austria, and with the first week in August the general European struggle had opened.

PART II.

THE FORCES OPPOSED.

HERE, then, at the beginning of August 1914, are the five great Powers about to engage in war.

Russia, France, and Great Britain, whom we will call the Allies, are upon one side ; the German Empire and Austria-Hungary, whom we will call the Germanic Powers, are upon the other.

We must at the outset, if we are to understand the war at all, see how these two combatant groups stood in strength one against the other when the war broke out. And to appreciate this contrast we must know two things—their geographical situation, and their respective weight in arms. For before we can judge the chances of two opponents in war, we have to know how they stand physically one to the other upon the surface of the earth, or we can-

not judge how one will attack the other, or how each will defend itself against the other. And we must further be able to judge the numbers engaged both at the beginning of the struggle and arriving in reinforcement as the struggle proceeds, because upon those numbers will mainly depend the final result.

Having acquired these two fundamental pieces of information, we must acquire a third, which is *the theories of war* held upon either side, and some summary showing which of these theories turned out in practice to be right, and which wrong.

For, after a long peace, the fortune of the next war largely depends upon which of various guesses as to the many changes that have taken place in warfare and in weapons will be best supported by practice, and what way of using new weapons will prove the most effective. Until the test of war is applied, all this remains guess-work; but under the conditions of war it ceases to be guess-work, and becomes either corroborated by experience or exploded, as the case may be. And of two opponents after a long peace, that one which has had the most foresight and has

guessed best what the effect of changes in armament and the rest will effect in practice is that one who has the best chance of victory.

We are going, then, in this Second Part of the little book, to see, first, the geographical position of the belligerents; secondly, their effective numbers; and, thirdly, what theories of war each held, and how far each was right or wrong.

(I) THE GEOGRAPHICAL POSITION OF THE BELLIGERENTS.

The position of the original belligerent countries (excluding Turkey) upon the map of Europe was that which will be seen upon the accompanying sketch map.

Of this belligerent area, which is surrounded by a thick black line, the part left white represents the territory of the Allies at the origin of the war—Great Britain, France, Russia, and Servia. This reservation must, however, be made: that in the case of Russia only the effective part is shown, and only the European part at that; Arctic Russia and Siberia are omitted. The part lightly shaded with

cross lines represents the Germanic body—to wit, the German Empire and Austria-Hungary.

1. The first thing that strikes the eye upon such a map is the great size of the Germanic body.

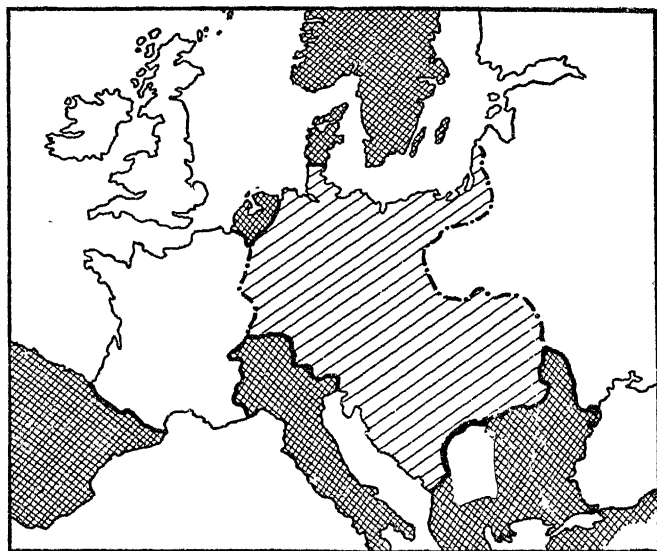

Sketch 4.

When one reads that “Germany” was being attacked by not only France and England, but also Russia; when one reads further that in the Far East, in Asia, Japan was putting in work for the Allies; and

when one goes on to read that Belgium added her effort of resistance to the "German" invasion, one gets a false impression that one single nation was fighting a vast coalition greatly superior to it. Most people had an impression of that kind, in this country at least, at the outset of the war. It was this impression that led to the equally false impression that "Germany" must necessarily be beaten, and probably quickly beaten.

The truth was, of course, that we were fighting something very much bigger than "Germany." We set out to fight something more than twice as big as Germany in area, and very nearly twice as big as the German Empire in mere numbers. For what we set out to fight was not the German Empire, but the German Empire *plus* the whole of the dominions governed by the Hapsburg dynasty at Vienna.

How weighty this Germanic body was geographically is still more clearly seen if we remember that Russia north of St. Petersburg is almost deserted of inhabitants, and that the true European areas of population which are in conflict—that is, the fairly well populated areas—are

more accurately represented by a modification of the map on page 81 in some such form as that on page 84, where the comparative density of population is represented by the comparative distances between the parallel cross-lines.

2. The next thing that strikes one is the position of the neutral countries. Supposing Belgium to have remained neutral, or, rather, to have allowed German armies to pass over her soil without actively resisting, the Germanic body would have been free to trade with neutral countries, and to receive support from their commerce, and to get goods through them over the whole of their western front, with the exception of the tiny section which stands for the frontier common to France and Germany. On the north, supposing the Baltic to be open, the Germanic body had a vast open frontier of hundreds of miles, and though Russia closed most of the eastern side, all the Roumanian frontier was open, and so was the frontier of the Adriatic, right away from the Italian border to Cattaro. So was the Swiss frontier and the Italian.

Indeed, if we draw the Germanic body

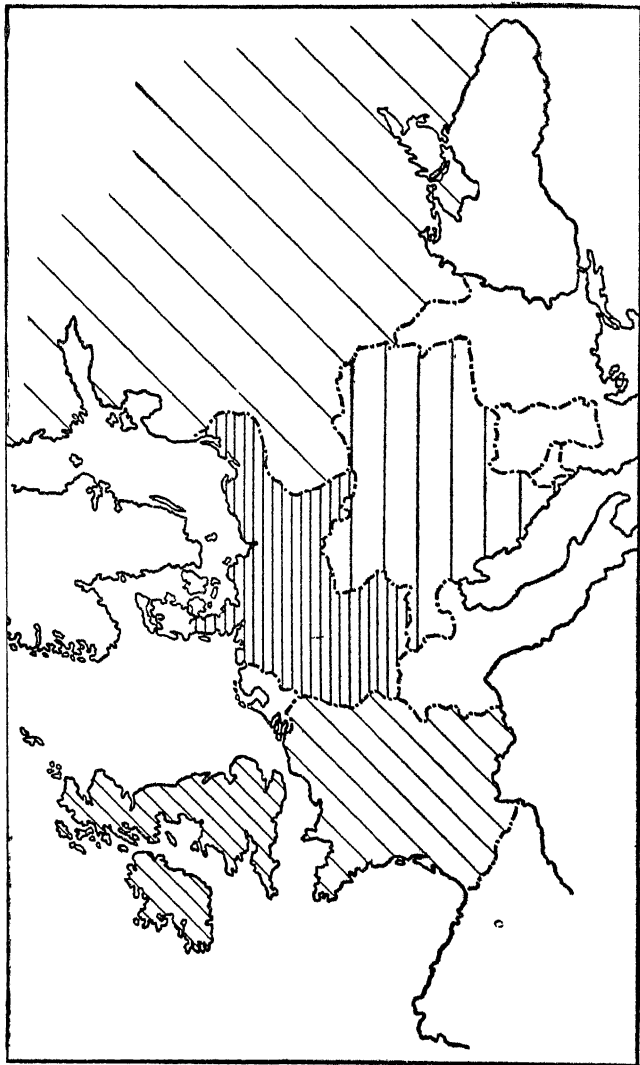

Sketch 5.

by itself surrounded by a frontier of dots, as in the accompanying sketch, and mark in a thick line upon that frontier those parts which touched on enemy's territory, and

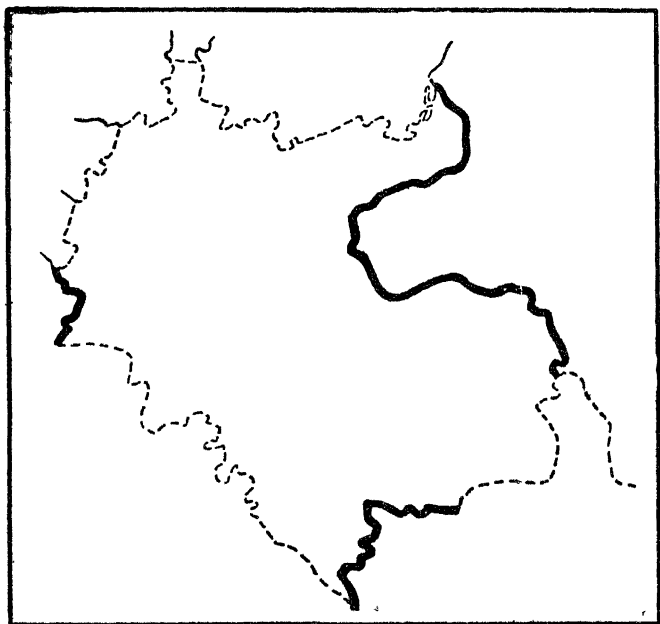

Sketch 6.

were therefore closed to supply, we shall be immediately arrested by the comparatively small proportion of that frontier which is thus closed.

It is well to carry this in mind during

the remainder of our study of this war, because it has a great effect upon the fighting power of Germany and Austria after a partial—but very partial—blockade is established by the Allied and especially by the British naval power.

3. The third thing that strikes one in such a map of the belligerent area is the way in which the Germanic body stands in the middle facing its two groups of enemies East and West.

The Geographical Advantages and Disadvantages of the Germanic Body.

With this last point we can begin a comparison of the advantages and disadvantages imposed by geographical conditions upon the two opponents, and first of these we will consider the geographical advantages and disadvantages of the Germanic body—that is, of the Austrian and German Empires—passing next to the corresponding advantages and disadvantages of the Allies.

The advantages proceeding from geographical position to Germany in particular, and to the Germanic body as a

whole, gravely outweigh the disadvantages. We will consider the disadvantages first.

The chief disadvantage under which the Germanic body suffered in this connection was that, from the outset of hostilities, it had to fight, as the military phrase goes, upon two fronts. That is, the commanders of the German and Austrian armies had to consider two separate campaigns, to keep them distinct in their minds, and to co-ordinate them so that they should not, by wasting too many men on the East or the West, weaken themselves too much on the other side of the field.

To this disadvantage some have been inclined to add that the central position of Austria and Germany in Europe helped the British and Allied blockade (I repeat, a very partial, timid, and insufficient blockade) of their commerce.

But this view is erroneous. The possibility of blockading Austria-Hungary and Germany from imports across the ocean was due not to their central but to their continental position ; to the fact that they were more remote from the ocean than France and Great Britain. It had nothing

to do with their central position between the two groups of the Allies.

Supposing, for instance, that Germany and Austria-Hungary had stood where Russia stands, and that Western Europe had been in alliance against them. Then they would have been in no way central; their position would have been an extreme position upon one side; and yet, so far as blockading goes, the blockade of them would have been infinitely easier.

Conversely, if Germany and Austria had been in the west, where Great Britain and France are, their enemies lying to the east of them could not have blockaded them at all.

As things are the blockade that has been established exists but is partial. As will be seen upon the following sketch map, the British Fleet, being sufficiently powerful, can search vessels the cargoes of which might reach the Germanic body directly through the Strait of Gibraltar (1), the Strait of Dover (2), or the North Sea between Scotland and Norway (3). But it is unable to prevent supplies reaching the Germanic body from Italy, whether by land or by sea (4), or through Switzerland

(5), or through Holland (6), or through Denmark (7), or across the frontier of Roumania (8); or, so long as the German Fleet is strongest in the Baltic, by way

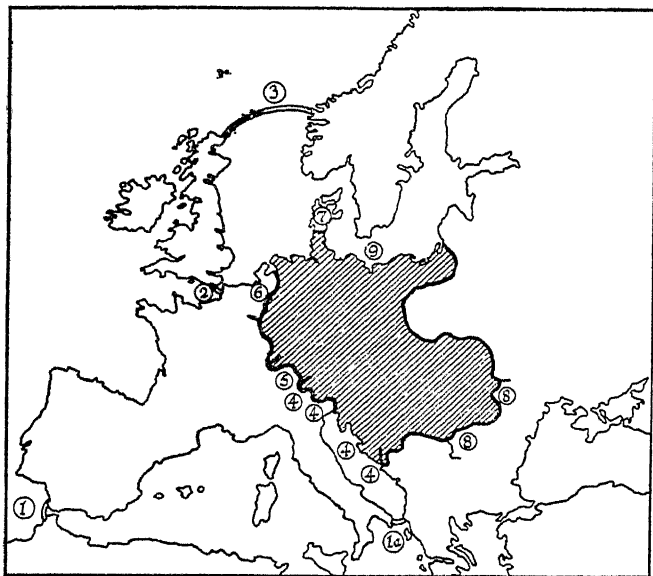

Sketch 7.

of Norway and Sweden across the Baltic (9).

The blockading fleet is even embarrassed as to the imports the Germanic body receives indirectly through neutral countries—that is, imports not produced in the importing countries themselves, but pro-

vided through the neutral countries as middlemen.

It is embarrassed in three ways.

(a) Because it does not want to offend the European neutral countries, which count in the general European balance of power.

(b) Because it does not wish to offend Powers outside Europe which are neutral in this war, and particularly the United States. Such great neutral Powers are very valuable not only for their moral support if it can be obtained, but on account of their great financial resources untouched by this prolonged struggle, and, what lies behind these, their power of producing materials which the Allies need just as much as Austria and Germany do.

(c) Because, even if you watch the supplies of contraband to neutrals, and propose to stop supplies obviously destined for German use, you cannot prevent Germany from buying the same material "made up" by the neutral: for example, an Italian firm can import copper ore quite straightforwardly, smelt it, and offer the metal in the open market. There is nothing to prevent a German merchant entering that market

and purchasing, unless Italy forbids all export of copper, which it is perfectly free not to do.

To leave this side question of blockade, and to return to the relative advantages and disadvantages of our enemy's central position, we may repeat as a summary of its disadvantages the single truth that it compels our enemy to fight upon two fronts.

All the rest is advantage.

It is an advantage that Germany and Austria-Hungary, as a corollary to their common central position, are in some part of similar race and altogether of a common historical experience. For more than a hundred years every part of the area dominated by the Germanic body—with the exception of Bosnia and Alsace-Lorraine—has had a fairly intimate acquaintance with the other part. The Magyars of Hungary, the Poles of Galicia, of Posen, of Thorn, the Croats of the Adriatic border, the Czechs of Bohemia, have nothing in race or language in common with German-speaking Vienna or German-speaking Berlin. But they have the experience of generations uniting them with Vienna and

with Berlin. In administration, and to some extent in social life, a common atmosphere spreads over this area, nearly all of which, as I have said, has had something in common for a hundred years, and much of which has had something in common for a thousand.

In a word, as compared with the Allies, the Germanic central body in Europe has a certain advantage of moral homogeneity, especially as the governing body throughout is German-speaking and German in feeling.

That is the first point of advantage—a moral one.

The second is more material. The Governments of the two countries, their means of communication and of supply, are all in touch one with another. Those governments are working in one field within a ring fence, and working for a common object. They are not only spiritually in touch; they are physically in touch. An administrator in Berlin can take the night express after dinner and breakfast with his collaborator in Vienna the next morning.

It so happens, also, that the communica-

tions of the two Germanic empires are exactly suited to their central position. There is sufficient fast communication from north to south to serve all the purposes necessary to the intellectual conduct of a war; there is a most admirable communication from east to west for the material conduct of that war upon two fronts. Whenever it may be necessary to move troops from the French frontier to the Russian, or from the Russian to the French, or for Germany to borrow Hungarian cavalry for the Rhine, or for Austria to borrow German army corps to protect Galicia, all that is needed is three or four days in which to entrain and move these great masses of men. There is no area in Europe which is better suited by nature for thus fighting upon two land frontiers than is the area of the combined Austrian and German Empire.

With these three points, then—the great area of our enemy in Europe, his advantage through neutral frontiers, and his advantage in homogeneity of position between distant and morally divided Allies—you have the chief marks of the geographical position he occupies, in so far as

this is the great central position of continental Europe.

But it so happens that the Germanic body in general, and the German Empire in particular, suffer from grave geographical disadvantages attached to their political character. And of these I will make my next points.

The Germanic body as a whole suffers by its geographical disposition, coupled with its political constitution, a grave disadvantage in its struggle against the Allies, particularly towards the East, because just that part of it which is thrust out and especially assailable by Russia happens to be the part most likely to be disaffected to the whole interests of the Germanic body; and how this works I will proceed to explain.

Here are two oblongs—A, left blank, and B, lightly shaded. Supposing these two oblongs combined to represent the area of two countries which are in alliance, and which are further so situated that B is the weaker Power to the alliance both (1) in his military strength, and (2) in his tenacity of purpose. Next grant that B is divided by the dotted line, CD, into

two halves—B not being one homogeneous State, but two States, B₁ and B₂.

Next let it be granted that while B₁ is more likely to remain attached in its alliance to A, B₂ is more separate from the alliance in moral tendency, and is also materially the weaker half of B. Finally, let the whole group, AB, be subject to the

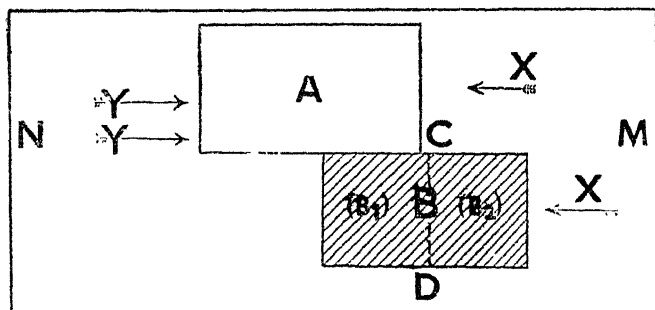

Sketch 8.

attack of enemies from the right and from the left (from the right along the arrows XX, and from the left along the arrows YY) by two groups of enemies represented by the areas M and N respectively.

It is obvious that in such a situation, if A is the chief object of attack, and is the Power which has both provoked the conflict and made itself the chief object

of assault by M and N, A is by this arrangement in a position *politically* weak.

That is, the strategical position of A is gravely embarrassed by the way in which his ally, B, separated into the two halves, B₁ and B₂, stands with regard to himself. B₂ is isolated and thrust outward. The enemy, M, upon the right, attacking along the lines XX, may be able to give B₂ a very bad time before he gets into the area of B₁, and long before he gets into the area of the stronger Power, A. It is open to M so to harass B₂ that B₂ is prepared to break with B₁ and give up the war; or, if the bond between B₂ and B₁ is strong enough, to persuade B₁ to give up the struggle at the same time that he does. And if B₂ is thus harassed to the breaking-point, the whole alliance, A plus B, will lose the men and materials and wealth represented by B₂, and *may* lose the whole shaded area, B, leaving A to support singly for the future the combined attacks of M and N along the lines of attack, XX and YY.

Now, that diagram accurately represents the political embarrassment in strategy of the German-Austro-Hungarian alliance.

B₁ is Austria and Bohemia ; B₂ is Hungary ; A is the German Empire ; M is the Russians ; N is the Allies in the West. With a geographical arrangement such as that of the Germanic alliance, a comparatively small proportion of the Russian forces detached to harry the Hungarian plain can make the Hungarians, who have little moral attachment to the Austrians and none whatever to the Germans, abandon the struggle to save themselves ; while it is possible that this outlier, being thus detached, will drag with it its fellow-half, the Austrian half of the dual monarchy, cause the Government of the dual monarchy to sue for peace, and leave the German Empire isolated to support the undivided attention of the Russians from the East and of the French from the West.

It is clear that if a strong Power, A, allied with and dependent for large resources in men upon a weaker Power, B, is attacked from the left and from the right, the ideal arrangement for the strong Power, A, would be something in the nature of the following diagram (Sketch 9), where the weaker Power stands protected in the territory of the stronger Power, and

where of the two halves of the weaker Power, B₂, the less certain half, is especially protected from attack.

Were Switzerland, Alsace-Lorraine, and the Rhineland, upon the one hand, the Hungarian plain, Russian Poland, and East Prussia, upon the other hand, united in one strong, patriotic, homogeneous German-speaking group with the Government of Berlin and the Baltic plain, and were

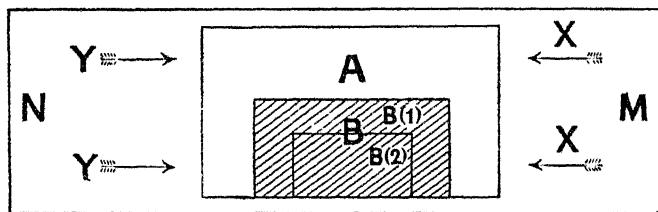

Sketch 9.

Bavaria, Switzerland, the Tyrol, Bohemia, to constitute the weaker and less certain ally, while the least certain half of that uncertain ally lay in Eastern Bohemia and in what is now Lower Austria, well defended from attack upon the East, the conditions would be exactly reversed, and the Austro-German alliance would be geographically and politically of the stronger sort. As it is, the combined accidents of geography

and political circumstance make it peculiarly vulnerable.

Having already considered in a diagram the way in which the geographical disposition of Austria-Hungary weakens Germany in the face of the Allies, let us

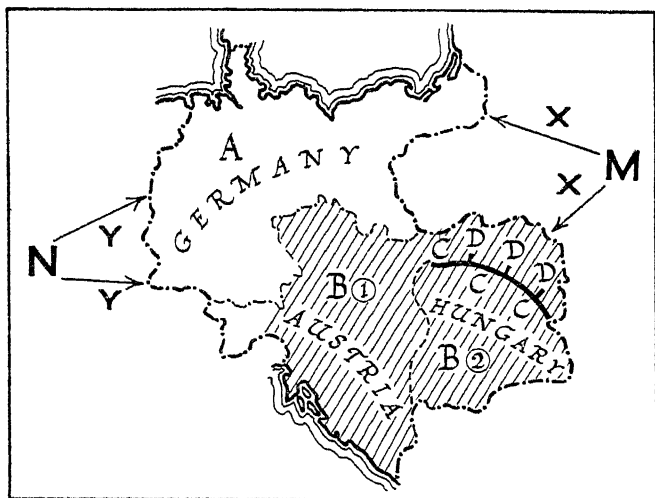

Sketch 10

translate that diagram into terms of actual political geography. These two oblongs, with their separate parts, are, as a fact, as follows: Where A is the German Empire, the shaded portion, B, is Austria-Hungary, and this last divided into B₁, the more certain Austrian part, and B₂, the less

certain exposed Hungarian part, the latter of which is only protected from Russian assault by the Carpathian range of mountains, CCC, with its passes at DDD. M, the enemy on the right, Russia, is attacking the alliance, AB, along XX; while the enemy on the left, N, France and her Allies, is attacking along the lines YY.

Hungary, Bz, is not only geographically an outlier, but politically is the weakest link in the chain of the Austro-Germanic alliance. The area of Hungary is almost denuded of men, for most of these have been called up to defend Germany, A, and in particular to prevent the invasion of Germany's territory in Silesia at S. The one defence Hungary has against being raided and persuaded to an already tempting peace is the barrier of the Carpathian mountains, CCC. When or if the passes shall be in Russian possession and the Russian cavalry reappear upon the Hungarian side of the hills, the first great political embarrassment of the enemy will have begun — I mean the first great political embarrassment to his strategy.

(a) Shall he try to defend those passes above all? Then he must detach German corps, and detach them very far from the areas which are vital to the core of the alliance—that is, to the German Empire, A.

(b) Shall he use only Hungarian troops to defend Hungary? Then he emphasizes the peculiar moral isolation of Hungary, and leaves her inclined, if things go ill, to make a separate peace.

(c) Shall he abandon Hungary? And let the Russians do what they will with the passes over the Carpathians and raid the Hungarian plain at large? Then he loses a grave proportion of his next year's wheat, much of his dwindling horse supply, his almost strangled sources of petrol. He tempts Roumania to come in (for a great sweep of Eastern Hungary is nationally Roumanian); and he loses the control in men and financial resources of one-half of his Allies if the danger and the distress persuade Hungary to stand out. For the Hungarians have no quarrel except from their desire to dominate the southern Slavs; to fight Austria's battles means very little to them, and to fight Germany's battles means nothing at all.

There is, of course, much more than this. If Hungary dropped out, could Austria remain? Would not the Government at Vienna, rather than lose the dual monarchy, follow Hungary's lead? In that case, the Germanic alliance would lose at one stroke eleven-twenty-fifths of its men. It would lose more than half of its reserves of men, for the Austrian reserve is, paradoxically enough, larger than the German reserve, though not such good material.

Admire how in every way this geographical and political problem of Hungary confuses the strategical plan of the German General Staff! They cannot here act upon pure strategics. They *cannot* treat the area of operations like a chess-board, and consider the unique object of inflicting a military defeat upon the Russians. Their inability to do so proceeds from the fact that this great awkward salient, Hungarian territory, is not politically subject to Berlin, is not in spiritual union with Berlin; may be denuded of men to save Berlin, and is the most exposed of all our enemy's territory to attack. Throughout the war it will be found that this problem perpetually presents itself to

the Great General Staff of the Prussians :
“ How can we save Hungary without weakening our Eastern line ? If we abandon Hungary, how are we to maintain our effectives ? ”

Such, in detail, is the political embarrassment to German strategy produced by the geographical situation and the political traditions of Hungary itself, and of Hungary's connection with the Hapsburgs at Vienna. Let us now turn to the even more important embarrassment caused to German strategy by the corner positions of the four essential areas of German territory.

This last political weakness attached to geographical condition concerns the German Empire alone.

Let us suppose a Power concerned to defend itself against invasion and situated between two groups of enemies, from the left and from the right, we will again call that Power A, the enemy upon the right M, and the enemy upon the left N, the first attacking along the lines XX, and the second along the lines YY.

Let us suppose that A has *political* reasons for particularly desiring to save from

invasion four districts, the importance of which I have indicated on Sketch 12 by shading, and which I have numbered 1, 2, 3, 4.

Let us suppose that those four districts happen to lie at the four exposed corners of the area which A has to defend. The Government of A knows it to be essential

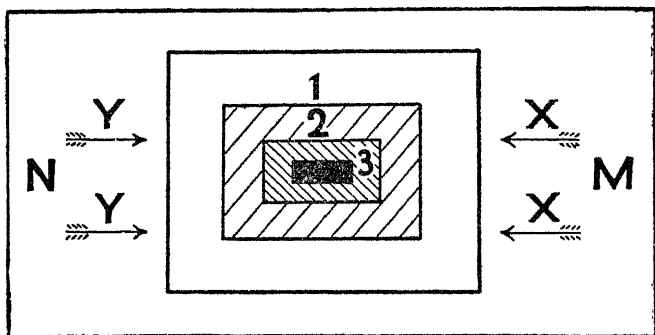

Sketch 11.

to success in the war that his territory should not be invaded. Or, at least, if it is invaded, it must not, under peril of collapse, be invaded in the shaded areas.

It is apparent upon the very face of such a diagram, that with the all-important shaded areas situated in the corners of his quadrilateral, A is heavily embarrassed. He must disperse his forces in order to

protect all four. If wastage of men compels him to shorten his line on the right against M, he will be immediately anxious as to whether he can dare sacrifice 4 to save 2, or whether he should run the dreadful risk of sacrificing 2 to save 4.

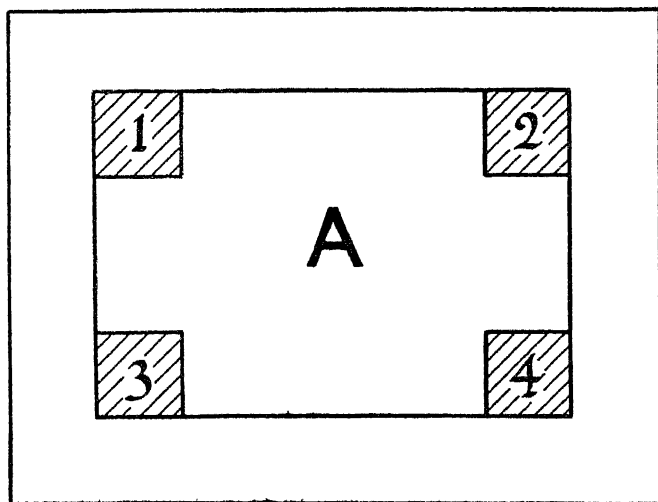

Sketch 12.

If wastage compels him to shorten his defensive line upon the left, he is in a similar quandary between 1 and 3.

The whole situation is one in which he is quite certain that a defensive war, long before he is pushed to extremities, will

compel him to "scrap" one of the four corners, yet each one is, for some political reason, especially dear to him and even perhaps necessary to him. Each he desires, with alternating anxieties and indecisions, to preserve at all costs from invasion; yet he cannot, as he is forced upon the defensive, preserve all four.

Here, again, the ideal situation for him would be to possess against the invader some such arrangement as is suggested by Sketch II. In this arrangement, if one were compelled unfortunately to consider four special districts as more important than the mass of one's territory, one would have the advantage of knowing that they were clearly distinguishable into less and more important, and the further advantage of knowing that the more important the territory was, the more central it was and the better protected against invasion.

Thus, in this diagram, the government of the general oblong, A, may distinguish four special zones, the protection of which from invasion is important, but which vary in the degree of their importance. The least important is the outermost, 1;

the more important is an inner one, 2; still more important is 3; and most important of all is the black core of the whole.

Some such arrangement has been the salvation of France time and time again, notably in the Spanish wars, and in the wars of Louis XIV., and in the wars of the Revolution. To some extent you have seen the same thing in the present war.

To save Paris was exceedingly important, next came the zone outside Paris, and so on up to the frontier.

But with the modern German Empire it is exactly the other way, and the situation is that which we found in Sketch 12; the four external corners are the essentials which must be preserved from invasion, and if any one of them goes, the whole political situation is at once in grave peril.

The strategical position of modern Germany is embarrassed because each of these four corners must be saved by the armies. 1 is Belgium—before the war indifferent to Germany, but now destined to be vital to her position—2 is East Prussia, 3 is Alsace-Lorraine, 4 is Silesia, and the German

commanders, as well as the German Government, must remain to the last moment—if once they are thrown on the defensive—in grave indecision as to which of the four can best be spared when invasion threatens; or else, as is more probable, they must disperse their forces in the attempt to hold all four at once. It is a situation which has but rarely occurred before in the history of war, and which has always proved disastrous.

Germany then must—once she is in Belgium—hold on to Belgium, or she is in peril; she must hold on to East Prussia, or she is in peril; she must hold on to Alsace-Lorraine, or she is in peril; and she must hold on to Silesia, or it is all up with her. If there were some common strategical factor binding these four areas together, so that the defence of one should involve and aid the defence of all, the difficulties thus imposed upon German strategy would be greatly lessened. Though even then the mere having to defend four outlying corners instead of a centre would produce confusion and embarrassment the moment numerical inferiority had appeared upon the side of the defence. But, as a

fact, there is no such common factor. Alsace-Lorraine and Belgium, East Prussia and Silesia, stand strategically badly separated one from the other. Even the two on the East and the two on the West, though apparently forming pairs upon the map, are not dependent on one system of communications, and are cut off from each other by territory difficult or hostile, while between the Eastern and the Western group there is a space of five hundred miles.

Let us, before discussing the political embarrassment to strategy produced by these four widely distant and quite separate areas, translate the diagram in the terms of a sketch map.

On the following sketch map, Belgium, Alsace-Lorraine, East Prussia, and Silesia are shaded, as were the four corners of the diagram. No. 1 is Belgium, 2 is East Prussia, 3 is Alsace-Lorraine, 4 is Silesia. The area occupied by the German Empire, including its present occupation of Belgium, is marked by the broad outline; and the areas shaded represent, not the exact limits of the four territories that are so important, but those portions of them which are essential: the non-

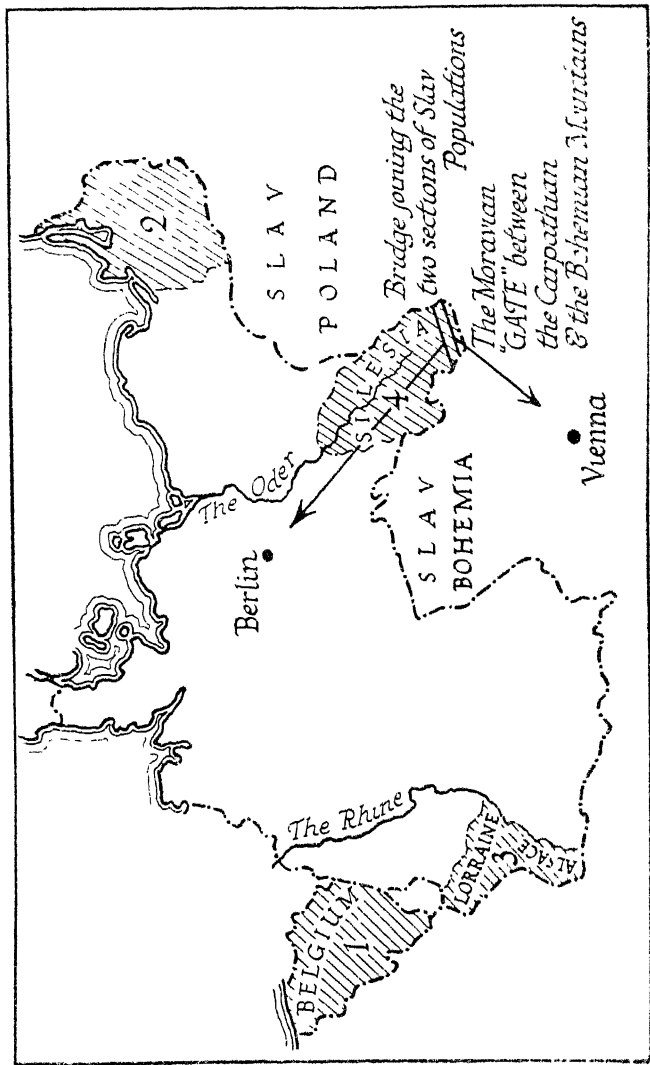

Sketch 13.

Polish portion of Silesia, the non-Polish portion of East Prussia, the plain of Belgium, and all Alsace-Lorraine.

Now the reason that each of these must at all costs be preserved from invasion is, as I have said, different in each case, and we shall do well to examine what those reasons are ; for upon them depends the political hesitation they inevitably cause to arise in the plans of the Great General Staff.

1. *Belgium.* The military annexation of Belgium has been a result of the war, and, from the German point of view, an unexpected result. Germany both hoped and expected that her armies would pass through Belgium as they did, in fact, pass through Luxembourg. The resistance of Belgium produced the military annexation of that country ; the reign of terror exercised therein has immobilized about 100,000 of the German troops who would otherwise be free for the front ; the checking of the advance into France has turned the German general political objective against England, and, to put the matter in the vaguest but most fundamental terms, the German mind has gradually

come, since October, to regard the retention of Belgium as something quite essential. And this because :—(a) It gives a most weighty asset in the bargaining for peace. (b) It gives a seaboard against England. (c) It provides ample munition, house-room, and transport facility, without which the campaign in North-eastern France could hardly be prolonged. (d) It puts Holland at the mercy of Germany, for she can, by retaining Belgium, strangle Dutch trade, if she chooses to divert her carriage of goods through Belgian ports. (e) It is a specific conquest; the Government will be able to say to the German people, “It is true we had to give up this or that, but Belgium is a definite new territory, the occupation of which and the proposed annexation of which is a proof of victory.” (f) The retention of Belgium has been particularly laid down as the cause of quarrel between Great Britain and Germany; to retain Belgium is to mark that score against what is now the special enemy of Germany in the German mind. (g) Antwerp is the natural port for all the centre of Europe in commerce westward over the

ocean. (*h*) With Belgium may go the Belgian colonies—that is, the Congo—for the possession of which Germany has worked ceaselessly year in and year out during the last fifteen years by a steady and highly subsidized propaganda against the Belgian administration. She has done it through conscious and unconscious agents; by playing upon the cupidity of French and British Parliamentarians, of rum shippers, upon religious differences, and upon every agency to her hand.

We may take it, then, that the retention of Belgium is in German eyes now quite indispensable. “If I abandon Belgium,” she says, “it is much more than a strategic retreat; it is a political confession of failure, and the moral support behind me at home will break down.”

If I were writing not of calculable considerations, but of other and stronger forces, I should add that to withdraw from Belgium, where so many women and children have been massacred, so many jewels of the past befouled or destroyed, so wanton an attack upon Christ and His Church delivered, would be a loss of Pagan prestige intolerably strong,

and a triumph of all that against which Prussia set out to war.

2. *Alsace-Lorraine.* But Alsace-Lorraine is also "indispensable." We have seen on an earlier page what the retention of that territory means. Alsace-Lorraine is the symbol of the old victory. It is the German-speaking land which the amazingly unreal superstitions of German academic pedantry discovered to be something sacredly necessary to the unity of an ideal Germany, though the people inhabiting it desired nothing better than the destruction of the Prussian name. It is more than that. It is the bastion beyond the Rhine which keeps the Rhine close covered; it is the two great historic fortresses of Strassburg and Metz which are the challenge Germany has thrown down against European tradition and the civilization of the West; it is something which has become knit up with the whole German soul, and to abandon it is like a man abandoning his title or his name, or surrendering his sword. Through what must not the German mind pass before its directors would consent to the sacrifice of such a fundamentally symbolic posses-

sion? There is defeat in the very suggestion; and the very suggestion, though it has already occurred to the Great General Staff, and has already, I believe, been mentioned in one proposal for peace, would be intolerable to the mass of the enemy's opinion.

3. *East Prussia.* East Prussia is sacred in another, but also an intense fashion. It is the very kernel of the Prussian monarchy. When Berlin was but a market town for the Electors of Brandenburg, those same Electors had contrived that East Prussia, which was outside the empire, should be recognized as a kingdom. Frederick the Great's father, while of Brandenburg an Elector, was in Prussia proper a king, a man who had emancipated that cradle of the Prussian power. The province in all save its southern belt (which is Polish) is the very essence of Prussian society: a mass of serfs, technically free, economically abject, governed by those squires who own them, their goods, and what might be their soil. The Russians wasted East Prussia in their first invasion, and they did well though they paid so heavy a price, for to wound

East Prussia was to wound the very soul of that which now governs the German Empire. When the landed proprietors fled before the Russian invasion, and when there fled with them the townsfolk, the serfs rose and looted the country houses. In a way quite different from Belgium, quite different from Alsace-Lorraine, East Prussia is essential. Forces will and must be sent periodically to defend that territory, however urgently they may be needed elsewhere, as the pressure upon Germany increases. The German commanders, if they forget East Prussia for a moment in the consideration of the other essential points, will, the moment their eyes are turned upon East Prussia again, remember with violent emotion all that the province means to the reigning dynasty and its supporters, and they will do anything rather than let that frontier go. The memory of the first invasion is too acute, the terror of its repetition too poignant, to permit its abandonment.

4. *Silesia*. Silesia, for quite other reasons (and remember that these different reasons for defending such various points are the essence of the embarrassment in

which German strategy will find itself), must be saved. It has been insisted over and over again in these pages what Silesia means. Its meaning is twofold. If Silesia goes, the safest, the most remote from the sea, the most independent of imports of the German industrial regions, is gone. Silesia is, again, the country of the great proprietors. Amuse yourselves by remembering the names of Pless and of Lichnowsky. There are dozens of others. But, most important of all, Silesia is what Belgium is not, what Alsace-Lorraine is not, what East Prussia is not—it is the strategic key. Who holds Silesia commands the twin divergent roads to Berlin northwards, to Vienna southwards. Who holds Silesia holds the Moravian Gate. Who holds Silesia turns the line of the Oder, and passes behind the barrier fortresses which Germany has built upon her Eastern front. Who holds Silesia strikes his wedge in between the German-speaking north and the German-speaking south, and joins hands with the Slavs of Bohemia. Not that we should exaggerate the Slav factor, for religion and centuries of varying culture disturb its unity. But

it is something. The Russian forces are Slav ; the resurrection of Poland has been promised ; the Czechs are not submissive to the German claim of natural mastery, and whoever holds Silesia throws a bridge between Slav and Slav if his aims are an extension of power in that race. For a hundred reasons Silesia must be saved.

Now put yourself in the position of the men who must make a decision between these four outliers—Belgium, Alsace-Lorraine, East Prussia, and Silesia—and understand the hesitation such divergent aims impose upon them. Hardly are they prepared to sacrifice one of the four when the defensive problem becomes acute, but its claims will be pressed in every conceivable manner—by public sentiment, by economic considerations, by mere strategy, by a political tradition, by the influence of men powerful with the Prussian monarchy, whose homes and wealth are threatened. “ If I am to hold Belgium, I must give up Alsace. How dare I do that ? To save Silesia I must expose East Prussia. How dare I ? I am at bay, and the East

must at all costs be saved. I will hold Prussia and Silesia, but to withdraw from Belgium and from beyond the Rhine is defeat." The whole thing is an embroglio. That conclusion is necessary and inexorable. It would not appear at all until, or if, numerical weakness imposed on the enemy a gradual concentration of the defensive; but once that numerical weakness has come, the fatal choices must be made. It may be that a strict, silent, and virile resolution, such as saved France this summer, a preparedness for particular sacrifices calculated beforehand, will determine first some one retirement and then another. It may be—though it is not in the modern Prussian temperament—that a defensive as prolonged as possible will be attempted even with inferior numbers, and that, as circumstances may dictate, Alsace-Lorraine or Belgium, Silesia or East Prussia will be the first to be deliberately sacrificed; but one must be, and, it would seem, another after, and in the difficulty of choice a wound to the German strategy will come.

The four corners are differently defensible—Alsace-Lorraine and Belgium only

by artifice, and with great numbers of men ; Silesia only so long as Austria (and Hungary) stand firm. East Prussia has her natural arrangement of lakes to make invasion tedious, and to permit defence with small numbers.

Between the two groups, Eastern and Western, is all the space of Germany—the space separating Aberdeen from London. Between each part of each pair, in spite of an excellent railway system, is the block in the one case of the Ardennes and the Eifel, in the other of empty, ill-communited Poland. But each is strategically a separate thing ; the political value of each a separate thing ; the embarrassment between all four insuperable.

Such is the situation imposed by the geography of the European continent upon our enemies, with the opportunities and the drawbacks which that situation affords and imposes.

I repeat, upon the balance, our enemies had geographical opportunities far superior to our own.

Our power of partial blockade (to which I will return in a moment) is more than counterbalanced by the separation which

Nature has determined between the two groups of Allies. The ice of the North, the Narrows of the Dardanelles, establish this, as do the Narrows of the Scandinavian Straits.

The necessity of fighting upon two fronts, to which our enemies are compelled, is more than compensated by that natural arrangement of the Danube valley and of the Baltic plain which adds to the advantage of a central situation the power of rapid communication between East and West; while the chief embarrassment of our enemies in their geographical arrangement, which is the outlying situation of Hungary coupled with the presence of four vital regions at the four external corners of the German Empire, is rather political than geographical in nature.

I will now turn to the converse advantages and disadvantages afforded and imposed by geographical conditions upon the Allies.

The Geographical Advantages and Disadvantages of the Allies.

It has been apparent from the above in what way the geographical circumstance

of Germany and Austria-Hungary advantaged and disadvantaged those two empires in the course of a war against East and West.

Let us next see how the Allies were advantaged and disadvantaged by their position.

1. The first great disadvantage which the Allies most obviously suffer is their separation one from the other by the Germanic mass.

The same central position which gives Germany and Austria-Hungary their power of close intercommunion, of exactly co-ordinating all their movements, of using their armies like one army, and of dealing with rapidity alternate blows eastward and westward, produces contrary effects in the case of the Allies. Even if hourly communication were possible by telegraph between the two main groups, French and Russian, that would not be at all the same thing as personal, sustained, and continuous contact such as is enjoyed by the group of their enemies.

But, as a fact, even the very imperfect and indirect kind of contact which can be established by telegraphing over great dis-

tances is largely lacking. The French and the Russians are in touch. The commanders can and do pursue a combined plan. But the communication of results and the corresponding arrangement of new dispositions are necessarily slow and gravely interrupted. Indeed, it is, as we shall see in a moment, one of the main effects of geography upon this campaign that Russia must suffer during all its early stages a very severe isolation.

In general, the Allies as a whole suffer from the necessity under which they find themselves of working in two fields, remote the one from the other by a distance of some six hundred miles, not even connected by sea, and geographically most unfortunately independent.

2. A second geographical disadvantage of the Allies consists in the fact that one of them, Great Britain, is in the main a maritime Power.

That this has great compensating advantages we shall also see, but for the moment we are taking the disadvantages separately, and, so counting them one by one, we must recognize that England's being an island (her social structure industrial-

ized and free from conscription, her interests not only those of Europe but those of such a commercial scattered empire as is always characteristic of secure maritime Powers) produces, in several of its aspects, a geographical weakness to the Allied position, and that for several reasons, which I will now tabulate :—

(a) The position of England in the past, her very security as an island, has led her to reject the conception of universal service. She could only, at the outset of hostilities, provide a small Expeditionary Force, the equivalent at the most of a thirtieth of the Allied forces.

(b) Her reserves in men who could approach the continental field in, say, the first year, even under the most vigorous efforts, would never reach anything like the numbers that could be afforded by a conscript nation. The very maximum that can be or is hoped for by the most sanguine is the putting into the field, after at least a year of war, of less than three-sixteenths of the total Allied forces, although her population is larger than that of France, and more than a third that of the enemy.

(c) She is compelled to garrison and de-

send, and in places to police, dependencies the population of which will in some cases furnish no addition to the forces of the Allies, and in all cases furnish but a small proportion.

(*d*) The isolation of her territory by the sea, coupled with her large population and its industrial character, makes Britain potentially the most vulnerable point in the alliance.

So long as her fleet is certainly superior to that of the enemy, and has only to meet oversea attack, this vulnerability is but little felt; but once let her position at sea be lost, or even left undecided, or once let the indiscriminate destruction of commercial marine be seriously begun, and she is at the mercy of that enemy. For she cannot feed herself save by supplies from without, and she cannot take part in the supplying of armies with men and munitions upon the continent.

(*e*) She is open to fear aggression upon any one of her independent colonies oversea, and yet she is not able to draw upon them for the whole of their potential strength, or, indeed, for more than a very small proportion of it. In other words, the

British Fleet guarantees some fifteen million of European race beyond the seas from attack by the enemy, but cannot draw from these fifteen million more than an insignificant fraction of the million of men and more which, fully armed, they might furnish; nor has she any control over their finance, so as to be able to count upon the full weight of their wealth; nor can she claim their resources in goods and munitions. She can only obtain these by paying for them.

There is here a very striking contrast between her position and that of the Germanic Powers.

(f) Her isolation and maritime supremacy, coupled with her industrial character, make her during the strain of equipment the workshop of the Allies. That this is a great advantage is evident; but the disadvantage attaching to it is that very large proportions of her manhood are necessarily withdrawn from the field for the purposes of her shipbuilding, her communications, her manufactory of arms and all kinds of supplies, her seafaring work, both civil and military.

Of the two other main Allies, the French

disadvantage may be thus summarized, and it is slight:—

(a) The French political frontier, as established since the defeat of the French in 1871, is an open frontier. It has no natural features upon which the defensive can rely. In the lack of this the French fortified at very heavy expense that portion of their frontier which faced their certain enemy, and established a line from Verdun to Belfort calculated to check the first movement of his offensive. But all the two hundred miles to the north of this, the whole line between Verdun and the North Sea, was virtually open. There were, indeed, certain fortified places upon that line, but they formed no consecutive system, and, as their armaments grew old, they were not brought up to date. The truth is, that the defence of France upon this frontier was really left to the co-operation of Belgium. If, as was believed to be almost certain, Prussian morals being what they are, the Prussian guarantee to respect Belgian neutrality would be torn up at the outbreak of war, then three great fortresses—Liége, Namur, and Antwerp—would hold up the enemy's advance in this

quarter, and perform the function of delay which the obsolete armament of the north-eastern French frontier could not perform. We shall see, when we come to the conflicting theories of warfare held by the various belligerents, what a grievous miscalculation this was, and how largely it accounted for the first disasters of the war. But, at any rate, let us remember, as our first point, the absence of any natural line of defence in France as against a German invasion, remembering, also, that the French would necessarily, at the beginning of any war, be upon the defensive on account of their inferior numbers. Had France, for instance, had along her frontiers, and just within them, such a line as Germany possesses in the Rhine, she would have fallen back at the outset upon that line. But she has no such advantage.

(b) The second disadvantage of the French geographically is one immixed with political considerations. The French have for centuries produced, and have for two thousand years believed in, central government. For at least three hundred years all the life of the nation has centred upon Paris ; all the railways and all the

great system of roads and most of the waterways of the north similarly have Paris for their nucleus. Now, this central ganglion of the whole French organism is but 120 miles from the frontier, ten days' easy marching. An enemy coming in from the north-east not only finds no natural obstacle in his way, but has Paris as nearly within his grasp as, say, Cologne is within the grasp of a French invasion of North Germany. This feature has had the most important consequences upon the whole of French history. It was particularly the determining point of 1870.

To meet the handicap, the French of our generation have combined two policies.

First, they have fortified the whole region of Paris so thoroughly that it has sometimes been called "a fortified province;" an area of nearly thirty miles across at its narrowest, and of something like from seven to eight hundred square miles, is comprised within this plan.

The weakness of this in the face of modern fire will again be dealt with when we come to the conflicting theories upon war established during the long peace.

Secondly, the French established a policy

whereby, if Paris were menaced in a future campaign, the Government should abandon that central point, and, in spite of the grave inconvenience proceeding from the way in which all material communications centred upon the capital and all established offices were grouped there, would withdraw the whole central system of government to Bordeaux, and leave Paris to defend itself, precisely as though it were of no more importance than any other fortified point. They would recognize the strategic values of the district; they would deliberately sacrifice its political and sentimental value. They would never again run the risk of losing a campaign because one particular area of the national soil happened to be occupied. The plans of their armies and the instructions of their Staff particularly warned commanders against disturbing any defensive scheme by too great an anxiety to save Paris.

If this were the disadvantage geographically of France, what was that of Russia?

Russia's geographical disadvantage was twofold. First, she had no outlet to an open sea in Europe save through the arctic port of Archangel. This port was natu-

rally closed for nearly half the year, and how long it might be artificially kept partially open by ice-breakers it remained for the war to prove. But even if it were kept open the whole year in this precarious fashion, it lay on the farther side of hundreds of miles of waste and deserted land connected only with the active centre of Russia by one narrow-gauge line of railway with very little rolling stock. The great eastern port of Vladivostok was nearly as heavily handicapped, and its immense distance from the scene of operations in the West, with which it was only connected by a line six thousand miles long, was another drawback. Russia might, indeed, by the favour of neutrals or of Allies, use warm water ports. If the Turks should remain neutral and permit supply to reach her through the Dardanelles, the Black Sea ports were open all the year round, and Port Arthur (nearly as far off as Vladivostok) was also open in the Far East. But the Baltic, in a war with Germany, was closed to her. Certain goods from outside could reach her from Scandinavia, round by land along the north of the Baltic, but very slowly and at great

expense. It so happened also that, as the war proceeded, this question of supply became unexpectedly important, because all parties found the expenditure of heavy artillery high-explosive ammunition far larger than had been calculated for, and Russia was particularly weak therein and dependent upon the West. This disadvantage under which Russia lay was largely the cause of her embarrassment, and of the prolongation of hostilities in the winter that followed the declaration of war.

The fact that Russia was ill supplied with railways, and hardly supplied at all with hard roads (in a climate where the thaw turned her deep soil into a mass of mud) is political rather than geographical, but it must be remembered in connection with this difficulty of supply.

If these, then, were the various disadvantages which geographical conditions had imposed upon the Allies, what were the corresponding advantages?

They were considerable, and may be thus tabulated :—

1. The western Allies stood between their enemies and the ocean. If they could

maintain superiority at sea through the great size and efficiency of the British Fleet, and through its additional power when combined with the French, they could at the least embarrass, and perhaps ultimately starve out the enemy in certain essential materials of war. They could not reduce the enemy to famine, for with care his territories, so long as they were not ravaged, would be just self-supporting. The nitrates for his explosives the enemy could also command, and, in unlimited quantity, iron and coal. But the raw material of textiles for his clothing, cotton for his explosives, copper for his shell, cartridge cases, and electrical instruments, antimony for the hardening of the lead necessary to his small-arm ammunition, to some extent petrol for his aeroplanes and his motor-cars, and india-rubber for his tyres and other parts of machinery, he must obtain from abroad. That he would be able in part to obtain these through the good offices of neutrals was probable; but the Allied fleets in the West would certainly closely watch the extent of neutral imports, and attempt, with however much difficulty and with however

partial success, to prevent those neutrals acting as a mere highroad by which such goods could pass into Germany and Austria. They would hardly allow, especially in the later phases of the war, Italy and Switzerland, Holland and Scandinavia, to act as open avenues for the supply of the Germanic body. Though they would have to go warily, and would find it essential to remain at peace with the nations whose commerce they thus hampered and in some sense controlled, the Allies in the West could in some measure, greater or less, embarrass the enemy in these matters.

Conversely, they could supply themselves freely with tropical and neutral goods, and even with munitions of war obtained from across the ocean, from Africa and from America.

So long as North-western France and the ports of Great Britain were free from the enemy this partial blockade would endure, and this freedom of supply for France and Britain from overseas would also endure.

2. The Allies had further the geographical advantage of marine transport for their troops—an important advantage to the

French, who had a recruiting ground in North Africa, and to the British, who had a recruiting ground in their dominions oversea, and, above all, an advantage in that it permitted the constant reinforcement of the continental armies by increasing contingents arriving from these islands.

Of geographical advantages attaching to the position of Russia only one can be discovered, and it consists in the immense extent and unity of the Russian Empire. This permitted operations upon a western front from the Baltic to the Carpathians, or rather to the Roumanian border, which vast line could never be firmly held against them by the enemy when once the Russians had trained and equipped a superior number of men. The German forces were sufficient, as events proved, long to maintain a strict cordon upon the shorter front between the Swiss frontiers and the sea, but upon the other side of the great field, between the Baltic and the Carpathians, they could never hope to establish one continued wall of resistance.

(2) THE OPPOSING STRENGTHS.

When nations go to war their probable fortunes, other things being equal, are to be measured in numbers.

Other things being equal, the numbers one party can bring against the other in men, coupled with the numbers of weapons, munitions, and other material, will decide the issue.

But in European civilization other things are more or less equal. Civilian historians are fond of explaining military results in many other ways, particularly in terms of moral values that will flatter the reader. But a military history, however elementary, is compelled to recognize the truth that normally modern war in Europe has followed the course of numbers.

Among the very first, therefore, of the tasks set us in examining the great struggle is a general appreciation of the numbers that were about to meet in battle, and of their respective preparation in material.

More than the most general numbers—more than brief, round statements—I shall not attempt. I shall not do more than state upon such grounds as I can

discover proportions in the terms of single units—as, to say that one nation stood to another in its immediate armed men as eight to five, or as two to twenty. Neither shall I give positive numbers in less than the large fractions of a million. But, even with such large outlines alone before one, the task is extraordinarily difficult.

It will almost certainly be found, when full details are available after the war, that the most careful estimates have been grievously erroneous in some particular. Almost every statement of fact in this department can be reasonably challenged, and the evidence upon matters which in civilian life are amply recorded and easily ascertainable is, in this department, everywhere purposely confused or falsified.

To the difficulty provided by the desire for concealment necessary in all military organization, one must add the difficulty presented by the cross categories peculiar to this calculation. You have to consider not only the distinction between active and reserve, but also between men and munitions, between munitions available according to one theory of war, and munitions available according to another.

You have to modify statical conclusions by dynamic considerations (thus you have to modify the original numbers by the rate of wastage, and the whole calculus varies progressively with the lapse of time as the war proceeds).

In spite of these difficulties, I believe it to be possible to put before the general reader a clear and simple table of the numbers a knowledge of which any judgment of the war involves, and to be fairly certain that this table will, when full details are available, be discovered not too inaccurate.

We must begin by distinguishing between the two sets of numbers with which we have to deal—the numbers of men, and the amount of munitions which these men have to use.

The third essential element, equipment, we need not separately consider, because, when one says “men” in talking of military affairs, one only means equipped, trained, and organized men, for no others can be usefully present in the field.

Let us start, then, with some estimate of the number of men who are about to take part in battle ; let us take for our

limits the convenient limits of a year, and let us divide that space of time arbitrarily into three parts or periods.

There was a first period in which the nations opposed brought into the field the men available in the first few weeks for immediate action. It is not possible to set a precise limit, and to say, "This period covers the first six" or "the first eight weeks;" but we can say roughly that, when we are speaking of this first period, we mean the time during which men for whom the equipment was all ready, whose progress and munitioning had all been organized, were being as rapidly as possible brought into play. Such an estimate is not equivalent to an estimate of the very first numbers that met in the shock of battle; those numbers were far smaller, and differed according to the rate of mobilization and the intention of the various parties. The estimate is only that of the total number which the various parties could, and therefore did, bring into play before men not hitherto trained as soldiers, or trained but not believed to be required in the course of the campaign—according as that

campaign had been variously foreseen by various governments—came in to swell the figures.

The conclusion of this first period would come, of course, gradually in the case of every combatant, and would come more rapidly in the case of some than in the case of others. But we are fairly safe if we take the general turning-point from the first period to the second to be the month of October 1914. The second period had begun for some—notably for Germany—with the first days of that month; it had already appeared for all, especially for England, before the beginning of November.

The second period is marked for all the combatants by the bringing into play of such forces as, for various reasons, the Government of each had once hoped would not be required. The German Empire might have marked them as not required, in the reasonable hope that victory would be quickly assured. The British Government might, from a very different standpoint, have believed them not to be required, because it regarded the work of its continental Allies as sufficient to

gain the common object, etc. But in the case of all, however various the motives, the particular mark of this second period is the straining to put into the field newly trained and equipped bodies which in the first period were, it was imagined, neither needed nor perhaps available.

This second period merges very gradually into the third, or final, period, which is that of the last effort possible to the belligerents. There comes a moment before the end of the first year when, in the case of most of the belligerents, every man who is available at all has been equipped, trained, and put forward, and after which there is nothing left but the successive batches of yearly recruits growing up from boyhood to manhood.

Although Britain is in a peculiar position, and Russia, through her tardiness in equipment, in a peculiar position of another kind, yet one may fairly say that the vague margin between the second period of growth and the third period of finality appears roughly somewhere round the month of June. It will fall earlier with Germany, a good deal earlier with France; but from the middle of May at

earliest to the end of June at latest may be said to mark the entry of the numerical factor into its third and final phase.

Let us take these three periods one by one.

The first period is by far the most important to our judgment of the campaign ; a misapprehension of it has warped most political statements made in this country, and most contemporary judgments of the war as a whole. It is impossible to get our view of the great European struggle—of its nature in the bulk—other than fantastically wrong, if we misapprehend the opening numbers with which it was waged.

There are three ways of getting at those numbers.

The first and worst way is the consulting of general statistics published before the war broke out. Thus we may see in almanacs the French army put down as a little over four million, the German at the same amount, the Russian at about five million, and so forth.

These figures have no relation to reality, because they omit a hundred modifying considerations—such as the age of the

reserves, the degree of training of the reserves, the organization prepared for the enrolment of untrained men, etc. The only element in them which is of real value is the statistics—when we can obtain them—of men actually present with the colours before mobilization, to which one may add, perhaps—or at any rate in the case of France and Germany—the numbers of the *active* reserve immediately behind the conscript army in peace.

The second method, which is better, but imperfect, is that which has particularly appealed to technical writers. It consists in numbering *units*; in noting the headquarters and the tale of army corps and of independent divisions.

The fault of this method is twofold. First, that only actual experience can tell one whether units are really being maintained during peace at full strength; and secondly, that only actual experience discovers how many new units can and will be created when war is joined. In other words, the fault of this method (necessary though it is as an adjunct to all military calculations) lies in its divorce from the reality of numbers.

At the end of the retreat from Moscow each army corps of the Grand Army still preserved its name, each regiment its nominal identity. And the roll was called by Ney, for instance, before the Beresina, division by division and regiment by regiment, and even in the regiments company by company ; but in most of these last there was no one to answer, and there is a story of one regiment for which one surviving man answered with regularity until he also died. What fights is numbers of living men—not headings ; and if five army corps are present, each having lost two-fifths of its men, three full army corps are a match for them.

The third method is that of common-sense. We must deduce from the results obtained, from the fronts covered, from the energy remaining after known losses, from the reports of intelligence, from the avenues of communication available, what least and what largest numbers can be present. We must correct such conclusions by our previous knowledge of the way in which each service regards its strength, which most depends upon reserves, how each uses his depots and

drafts, what machinery it has for training the untrained and for equipping them. This complicated survey taken, we can arrive at general figures.*

Using that method, and applying it to the present campaign, I think we shall get something like the following.

*The Figures of the First Period, say
to October 1-31, 1914.*

Germany put across the Rhine in the first period (without counting a certain small proportion of Hungarian cavalry and Austrian artillery) rather more than two and a quarter million men. She put into the Eastern field first a quarter of a million, which rapidly grew to half a million, and before the end of October to nearly a million; a balance of rather more than another million she used for filling gaps and for keeping her strength

* Thus, after these lines were written, I had occasion in *Land and Water* to estimate the garrison of Przemysl before the figures were known. The element wherewith to guide one's common sense was the known perimeter to be defended; and arguing from this, I determined that a minimum of not less than 100,000 men would capitulate. I further conceived that the total losses could hardly be less than 40,000, and I arrived at an original force of between three and four corps.

at the full, and also in particular cases (as in her violent attempt to break out through Flanders, or rather the beginning of that attempt) for the immediate reinforcement of a fighting line. Say that Germany put into the field altogether five million men in the first period, and you are saying too much. Say that she put into the field altogether in the first period four and a quarter million men, and you are saying probably somewhat too little.

France met the very first shock with about a million men, which gradually grew in the fighting line to about a million and a half. Here the limit of the French force immediately upon the front will probably be set. The numbers continued to swell long before the end of the first period and well on into the second, but they were kept in reserve. Counting the men drafted in to supply losses and the reserve, it is not unwise to put at about two and a half million men the ultimate French figure, of which one and a half million formed, before the end of the first period, the immediate fighting force.

Austria was ordered by the Germans to put into the field, as an initial body to check any Russian advance and to confuse the beginning of Russian concentration, about a million men; which in the first period very rapidly grew to two million, and probably before the end of the first period to about two million and a half.

Russia put into the field during the first weeks of the war some million and a quarter, which grew during the first period (that is, before the coming of winter had created a very serious handicap, to which allusion will presently be made) to perhaps two million and a half at the very most. I put that number as an outside limit.

Servia, of men actually present and able to fight, we may set down at a quarter of a million; and Belgium, if we like, at one hundred thousand—though the Belgian service being still in a state of transition, and the degree of training very varied within it, that minor point is disputable. Indeed it is better, in taking a general survey, to consider only the five Great Powers concerned.

Of these the fifth, Great Britain, though destined to exercise by sea power and by her recruiting field a very great ultimate effect upon the war, could only provide, in this first period upon the Continent, an average of one hundred thousand men. To begin with, some seventy-five thousand, dwindling through losses to little more than fifty thousand, replenished and increased to about one hundred and twenty-five thousand, and approaching, as the end of the first period was reached, one hundred and fifty thousand men actually present upon the front.

We can now set down these figures in the shape of simple units, and see how the numerical chances stood at the opening of the campaign.

The enemy sets out with **32** men, of whom he bids **10** men against the Russians, and sends **22** against the French. The Russians meet the **10** men with about **12**, and the French meet the **22** with about **10**; but as they have not the whole **22** to meet in the first shock, they are struck rather in the proportion of **10** to **16** or **17**, while the presence of the British contingent makes them rather

more than **10** $\frac{1}{2}$. But these initial figures rapidly change with the growth of the armies, and before the first period is over the Germans have **22** in the West against **15** French and **1** British, making **16**; while in the East the Russian **12** has grown to, say, **24**, but the Austro-Germans in the East, against those **24**, have grown to be quite **32**. And there is the numerical situation of the first period clearly, and I think accurately, put, *supposing the wastage to be equal in proportion throughout all the armies*. The importance of appreciating these figures is that they permit us to understand why the enemy was morally certain of winning, quite apart from his right judgment on certain disputed theories of war (to which I shall turn in a moment), and quite apart from his heavy secret munitioning, which was of such effect in the earlier part of the campaign. He was ready with forces which he knew would be overwhelming, and how superior he was thus numerically in that first period can best be appreciated, I think, by a glance at the diagram on the next page.

It is no wonder that he made certain of

a decisive success in the West, and of the indefinite holding up or pushing back of

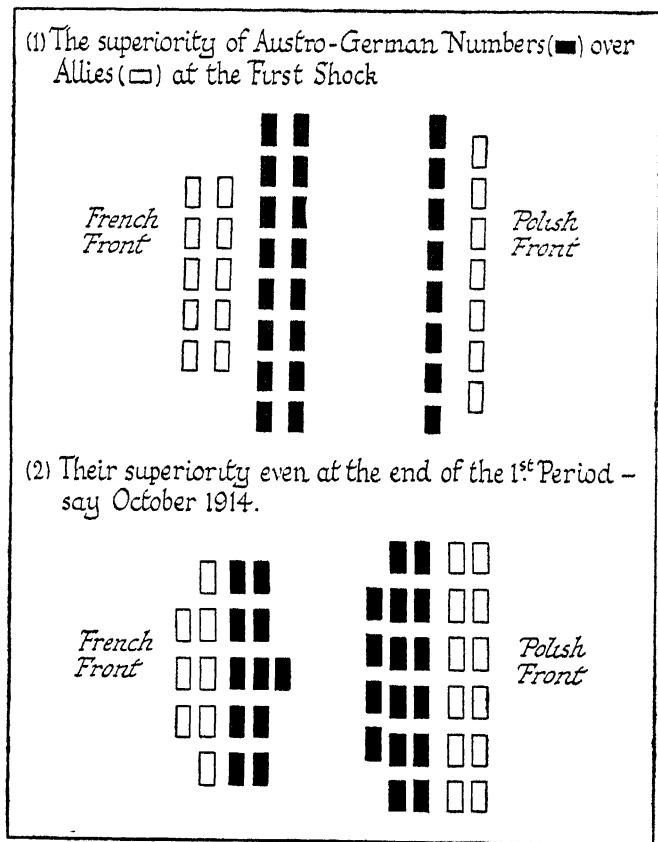

Sketch 14.

the Russian forces in the East. It is no wonder that he confidently expected a

complete victory before the winter, and the signing of peace before the end of the year. To that end all his munitioning, and even the details of his tactics, were directed.

*The Figures of the Second Period, say to
April 15-June 1, 1915.*

The second period saw in the West, and, in the enemy's case, a very great change proceeding by a number of minute steps, but fairly rapid in character.

The French numbers could not grow very rapidly, because the French had armed every available man. They could bring in a certain number of volunteers; but neither was it useful to equip the most of the older men, nor could they be spared from those duties behind the front line which the much larger population of the enemy entrusted to men who, for the most part, had received no regular training. The French did, however, in this second period, gradually grow to some two and a half million men, behind which, ready to come in for the final period, were about a third of a million young recruits.

Great Britain discovered a prodigious effort. She had already, comparatively early in the second period, put across the sea nearly half a million men, and drafts were perpetually arriving as the second period came to a close; while behind the army actually upon the Continent very large bodies—probably another million in number—hastily trained indeed, and presented with a grave problem in the matter of officering, but of excellent material and *moral*, were ready to appear, before the end of the second period or at its close, the moment their equipment should be furnished. Counting the British effort and the French together, one may say that, without regard to wastage, the Allies in the West grew in the second period from the original 16 to over 30, and might grow even before the second period was over to 35 or even more.

On the enemy's side (neglecting wastage for the moment) there were the simplest elements of growth. Each Power had docketed every untrained man, knew his medical condition, where to find him, where and how to train him. The German Empire had during peace taken about

one-half of its young men for soldiers. It had in pure theory five million untrained men in the reserve, excluding the sick, and those not physically efficient for service.

In practice, however, a very large proportion of men, even of the efficient, must be kept behind for civilian work; and in an industrial country such as Germany, mainly urban in population, this proportion is particularly large. We are safe in saying that the German army would not be reinforced during the second period by more than two and a half million men. These were trained in batches of some 800,000 each; the equipment had long been ready for them, and they appeared mainly as drafts for filling gaps, but partly as new formations in groups—the first going in or before November, the second in or before February. A third and last group was expected to have finished this rather elementary training somewhere about the end of April, so that May would complete the second period in the German forces.

Austria-Hungary, by an easily appreciable paradox, possessed, though but 80

per cent. of the Germans in population, a larger available untrained reserve. This was because that empire trained a smaller proportion of its population by far than did the Germans. It is probable that Austria-Hungary was able to train and put forward during the second period some three million men.

It is a great error, into which most critics have fallen, to underestimate or to neglect the Austro-Hungarian factor in the enemy's alliance. Without thus nearly doubling her numbers, Germany could not have fought France and Russia at all, and a very striking feature of all the earlier weeks of 1915 was the presence in the Carpathians of increasing Austro-Hungarian numbers, which checked for more than three months all the Russian efforts upon that front.

Say that Austria-Hungary nearly doubled her effectives (apart from wastage) in this second period, and you will not be far wrong.

Russia, which upon paper could almost indefinitely increase during the second period her numbers in the field, suffered with the advent of winter an unexpected

blow. Her equipment, and in particular her munitioning (that is, her provision of missiles, and in especial of heavy shell), must in the main come from abroad. Now the German command of the Baltic created a complete blockade on the eastern frontier of Russia, save upon the short Roumanian frontier; and the entry of Turkey into the campaign on the side of the enemy, which marked the second period, completed that blockade upon the south, and shut upon Russia the gate of the Dardanelles. The port of Archangel in the north was ice-bound, or with great difficulty kept partially open by ice-breakers, and was in any case only connected with Russia by one narrow-gauge and lengthy line; while the only remaining port of Vladivostok was six thousand miles away, and closed also during a part of the winter.

In this situation it was impossible for the great reserves of men which Russia counted on to be put into the field, and the Russians remained throughout the whole of this second period but little stronger than they had been at the end of the first. If we set them down at

perhaps somewhat over three millions (excluding wastage) towards the end of this second period, we shall be near to a just estimate.

We can now sum up and say that, *apart from wastage*, the forces arrayed against each other after this full development should have been about 120 men for the central powers of the enemy—35 (and perhaps ultimately 40) men against them upon the West, and, until sufficient Russian equipment could at least be found, only some 30 men against them upon the East.

Luckily such figures are wholly changed by the enormous rate of the enemy's wastage. The Russians had lost men almost as rapidly as the enemy, but the Russian losses could be and were made good. The handicap of the blockade under which Russia suffered permitted her to maintain only a certain number at the front, but she could continually draft in support of those numbers; and though she lost in the first seven months of the war quite four hundred thousand in prisoners, and perhaps three-quarters of a million in other casualties, her strength of some-

what over three millions was maintained at the close of the first period.

In the same way drafts had further maintained the British numbers. The French had lost not more than one-fifth of a million in prisoners, and perhaps a third of a million or a little more in killed and permanently disabled—that is, unable to return to the fighting line. In the case of both the French and the British sanitary conditions were excellent.

You have, then, quite 35 for your number in the West, and quite 33 for your number in the East of the Allied forces at the end of the winter; but of your enemy forces you may safely deduct 45—50 might be a truer estimate; and it is remarkable that those who have watched the matter carefully at the front are inclined to set the total enemy losses higher than do the critics working at home. But call it only 45 (of which 5 are prisoners), and you have against the 68 Allies in East and West no more at the end of this second period than 75 of the enemy.

The following diagram illustrates in

graphic form the change that six months have produced.

In other words, at the end of the winter and with the beginning of the spring, although the enemy still has a numerical preponderance, it is no longer the over-

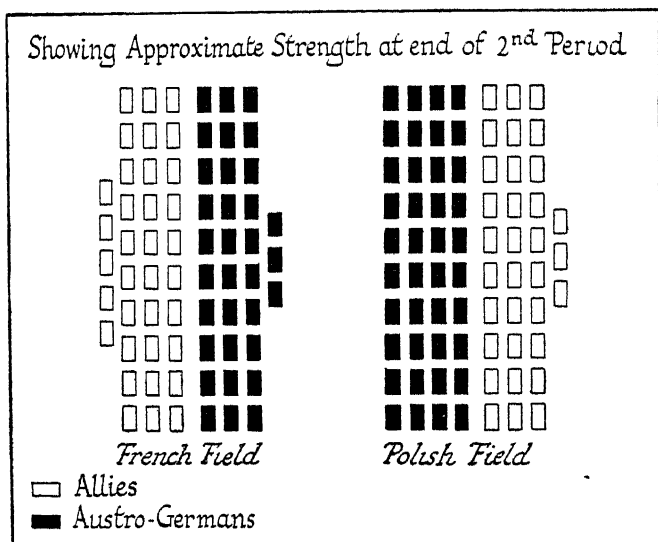

Sketch 15.

whelming thing it was when the war began, and that change in numbers explains the whole change in the campaign.

The enemy was certain of winning mainly because he was fighting more than equal in the East, and at first nearly

two to one, later quite four to three, in the West. Those are the conditions of the late summer of 1914. 1915, before it was a third over, had seen the numbers nearly equalized. With the summer of 1915 we might hope to see the numbers at last reversed, and, after so many perilous months, a total (not local) numerical majority at last appearing upon the side of the Allies. If ever this condition shall arrive before the enemy can accomplish a decisive result in either field the tide will have turned.

The third period belongs at the moment of writing to the future. All we can say of it is that it presents for the enemy no considerable field of recruitment; but while in the West it offers no increase to the French, it does offer another five units at least, and possibly another six or eight, to the British; and to the Russians, if the blockade can be pierced at any point, or if the change of weather, coupled with the broadening of the gauge of the railway to Archangel, permits large imports, an almost indefinite increase in number—certainly an increase of two millions, or twenty of the units we

were dealing with in the figures given above.

So much, then, for the numerical factor in men which dominates the whole campaign.

When we turn from this to the second factor—that of munitions—we discover something which can be dealt with far more briefly, but which follows very much the same line.

The enemy in the first period of the war had, if anything, an even greater superiority in munitioning than in men. This superiority was due to two distinct causes. In the first place, as we shall see in a few pages, his theory upon a number of military details was well founded; in the second place, *he made war at his own chosen moment, after three years of determined and largely secret preparation.*

As to the first point:—

We may take as a particular example of these theories of war the enemies' reliance upon heavy artillery—and in particular upon the power of the modern high explosive and the big howitzer—to destroy permanent fortification rapidly, and to have an effect in the field, particularly in

the preparation of an assault, which the military theories of the Allies had wrongly underestimated. It is but one example out of many. It must serve for the rest, and it will be dealt with more fully in the next section. The Germans to some extent, and much more the Austrians, prepared an immensely greater provision of heavy ammunition than their opponents, and entered the field with large pieces of a calibre and in number quite beyond anything that their opponents had at the outset of the campaign.

As to the second point:—

No peaceful nations, no nations not designing a war at their own hour, lock up armament which may be rendered obsolete, or, in equipment more extensive than the reasonable chances of a campaign may demand, the public resources which it can use on what it regards as more useful things. Such nations, to use a just metaphor, “insure” against war at what they think a reasonable rate. But if some one Government in Europe is anarchic in its morals, and proposes, while professing peace, to declare war at an hour and a day chosen by itself, it will obviously have

an overwhelming advantage in this respect. The energy and the money which it devotes to the single object of preparation cannot possibly be wasted ; and, if its sudden aggression is not fixed too far ahead, will not run the risk of being sunk in obsolete weapons.

Now it is clearly demonstrable from the coincidence of dates, from the exact time required for a special effort of this kind, and from the rate at which munitions and equipment were accumulated, that the Government at Berlin came to a decision in the month of July 1911 to force war upon Russia and upon France immediately after the harvest of 1914 ; and of a score of indications which all converge upon these dates, not one fails to strike them exactly by more than a few weeks in the matter of preparation, by more than a few days in the date at which war was declared.

Under those circumstances, Berlin with her ally at Vienna had the immense numerical advantage over the French and the Russians when war was suddenly forced upon those countries on the 31st of July last year.

But, as in the case of men, the advantage

would only be overwhelming during the first period. The very fact that the war had to be won quickly involved an immense expenditure of heavy ammunition in the earlier part of it, and this expenditure, if it were not successful, would be a waste.

It takes about five months to produce a heavy piece, and the rate of production of heavy ammunition, though slow, is measurable. At the moment of writing this, towards the close of the second period, the balance is not yet redressed, but it is in a fair way to be redressed. The imperfect and too tardy blockade to which the enemy is somewhat timidly subjected is a factor in aid of this; and we may be fairly confident that, if a third period is reached before the enemy shall have the advantage of a decision, there will be a preponderance of munitioning upon the Allied side in the West and the East which will be, if anything, of superior importance to the approaching preponderance in numbers.

Having thus briefly surveyed the opposing strength of either combatant, checked and measured as it varied with the progress of the war, we will turn to the

moral opposition of military theory between the one party and the other, and show how here again that, *save in the most important matter of all, grand strategy*, the enemy was on the highroad to the victory which he confidently and, for that matter, reasonably expected.

(3) THE CONFLICTING THEORIES OF WAR.

The long peace which the most civilized parts of Europe had enjoyed for now a generation left more and more uncertain the value of theories upon the conduct of war, which theories had for the most part developed as mere hypotheses untested by experience during that considerable period. The South African and the Manchurian war had indeed proved certain theories sound and others unsound, so far as their experience went; but they were fought under conditions very different from those of an European campaign, and the progress of material science was so rapid in the years just preceding the great European conflict that the mass of debated theories still remained untried at its outbreak.

The war in its first six months thor-

oughly tested these theories, and proved, for the greater part of them, which were sound in practice and which unsound. I will tabulate them here, and beg the special attention of the reader, because upon the accuracy of these forecasts the first fortunes of the war depended.

I. A German theory maintained that, with the organization of and the particular type of discipline in the German service, attacks could be delivered in much closer formation than either the French or the English believed to be possible.

The point is this : After a certain proportion of losses inflicted within a certain limit of time, troops break or are brought to a standstill. That was the universal experience of all past war. When the troops that are attacking break or are brought to a standstill, the attack fails. But what you cannot determine until you test the matter in actual war is what numbers of losses in what time will thus destroy an offensive movement. You cannot determine it, because the chief element in the calculation is the state of the soldier's mind, and that is not a measurable thing. One had only the lessons of the past to help one.

166 A GENERAL SKETCH OF

The advantages of attacking in close formation are threefold.

(a) You launch your attack with the least possible delay. It is evident that spreading troops out from the column to the line takes time, and that the more extended your line the more time you consume before you can strike.

If I have here a hundred units advancing in a column towards the place where they are to attack (and to advance in column



Sketch 16.

is necessary, because a broad line cannot long keep together), then it is evident that if I launched them to the attack thus:—

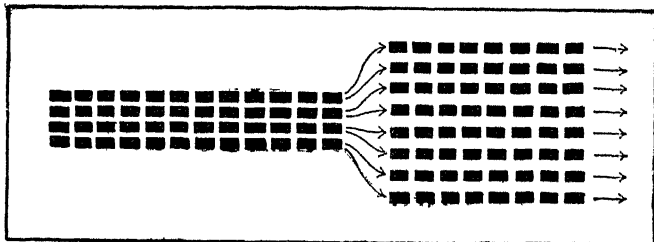

Sketch 17.

packed close together, I get them into that

formation much more quickly than if, before attacking, I have to spread them out thus :—

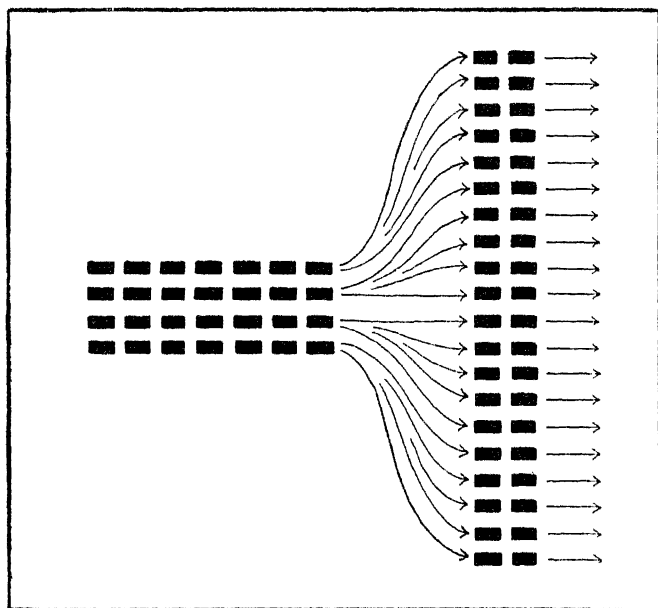

Sketch 18.

(b) The blow which I deliver has also evidently more weight upon it at a given point. If I am attacking a hundred yards of front with a hundred units of man and missile power, I shall do that front more harm in a given time than if I am attacking with only fifty such units.

(c) In particular circumstances, where troops *have* to advance on a narrow front, as in carrying a bridge or causeway or a street or any other kind of defile, my troops, if they can stand close formation and the corresponding punishment it entails, will be more likely to succeed than troops not used to or not able to bear such close formation. Now, such conditions are very numerous in war. Troops are often compelled, if they are to succeed, to rush narrow gaps of this kind, and their ability to do so is a great element in tactical success.

I have here used the phrase "if they can stand close formation and the corresponding punishment it entails," and that is the whole point. There are circumstances—perhaps, on the whole, the most numerous of all the various circumstances in war—in which close formation, if it can be used, is obviously an advantage; but it is equally self-evident that the losses of troops in close formation will be heavier than their losses in extended order. A group is a better target than a number of dispersed, scattered points.

Now, the Germans maintained in this

connection not only, as I have said, that they could get their men to stand the punishment involved in close formation, but also that :—

(a) The great rapidity of such attacks would make the *total* and *final* wastage less than was expected, and further :—

(b) That the heavy wastage, such as it was, was worth while, because it would lead to very rapid strategical decision as well as tactical. In other words, because once you had got your men to stand these heavy *local* losses and to suffer heavy *initial* wastage, you would win your campaign in a short time, so that the high-rate wastage not being prolonged need not be feared.

Well, in the matter of this theory, the war conclusively proved the following points :—

(a) The Germans were right and the Allies were wrong with regard to the mere possibility of using close formations. The German temper, coupled with the type of discipline in the modern German service, did prove capable of compelling men to stand losses out of all proportion to what the Allies expected they could stand, and

yet to continue to advance neither broken nor brought to a standstill. But—

(*b*) The war also proved that, upon the whole, and taking the operations in their entirety, such formations were an error. In case after case, a swarm of Germans advancing against inferior numbers got home after a third, a half, or even more than a half of their men had fallen in the first few minutes of the rush. But in many, many more cases this tactical experiment failed. Those who can speak as eye-witnesses tell us that, though the occasions on which such attacks actually broke were much rarer than was expected before the war began, yet the occasions on which the attack was thrown into hopeless confusion, and in which the few members of it that got home had lost all power to do harm to the defenders, were so numerous that the experiment must be regarded as, upon the whole, a failure. It may be one that no troops but Germans could employ. It is certainly not one which any troops, after the experience of this war, will copy.

(*c*) Further, the war proved even more conclusively that the wastage was not worth while. The immense expense in

men only succeeded where there was an overwhelming superiority in number. The strategical result was not arrived at quickly (as the Germans had expected) through this tactical method, and after six months of war, the enemy had thrown away more than twice and nearly three times as many men as he need have sacrificed had he judged sanely the length of time over which operations might last.

II. Another German theory had maintained that modern high explosives fired from howitzers and the accuracy of their aim controlled by aircraft would rapidly and promptly dominate permanent fortification.

This theory requires explanation. Its partial success in practice was the most startling discovery and the most unpleasant one to the Allies of the early part of the war.

In the old days, say up to ten years ago or less, permanent fortification mounting heavy guns was impregnable to direct assault if it were properly held and properly munitioned. It could hold out for months. Its heavy guns had a range superior to any movable guns that could be brought

against it—indeed, so very heavily superior that movable guns, even if they were howitzers, would be smashed or their crews destroyed long before the fortress was seriously damaged by them.

A howitzer is but a form of mortar, and all such pieces are designed to lob a projectile instead of throwing it. The advantage of using these instruments

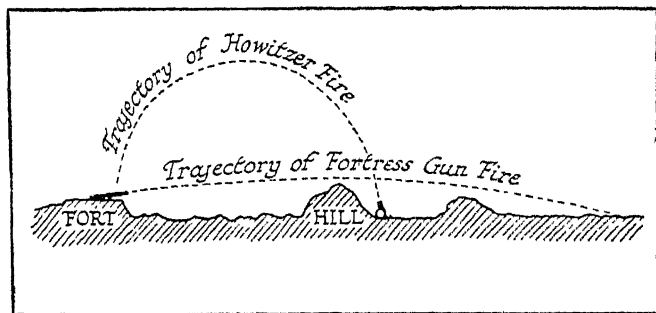

Sketch 19

when you are besieging permanent works is that you can hide them behind an obstacle, such as a hill, and that the heavy gun in the fortress cannot get its shell on to them because that shell has a flatter trajectory. The disadvantage is that the howitzer has a very much shorter range than the gun size for size.

Here is a diagram showing how neces-

sarily true this is. The howitzer, lobbing its shell with a comparatively small charge, has the advantage of being able to hide behind a steep bit of ground, but on such a trajectory the range is short. The gun in the fortress does not lob its shell, but throws it. The course of the gun shell is much more straight. It therefore can only hit the howitzer and its crew indirectly by exploding its shell just above them. Until recently, the gun was master of the howitzer for three reasons :—

First, because the largest howitzers capable of movement and of being brought up against any fortress and shifted from one place of concealment to another were so small that their range was insignificant. Therefore the circumference on which they could be used was also a small one ; their opportunities for hiding were consequently reduced ; the chances of their emplacement being immediately spotted from the fortress were correspondingly high, and the big gun in the fortress was pretty certain to overwhelm the majority of them at least. It is evident that the circumference $a\beta\gamma$ offers far more chances of hiding than the circumference ABC, but

a still more powerful factor in favour of the new big howitzer is the practical one that at very great ranges in our climate the chances of spotting a particular place are

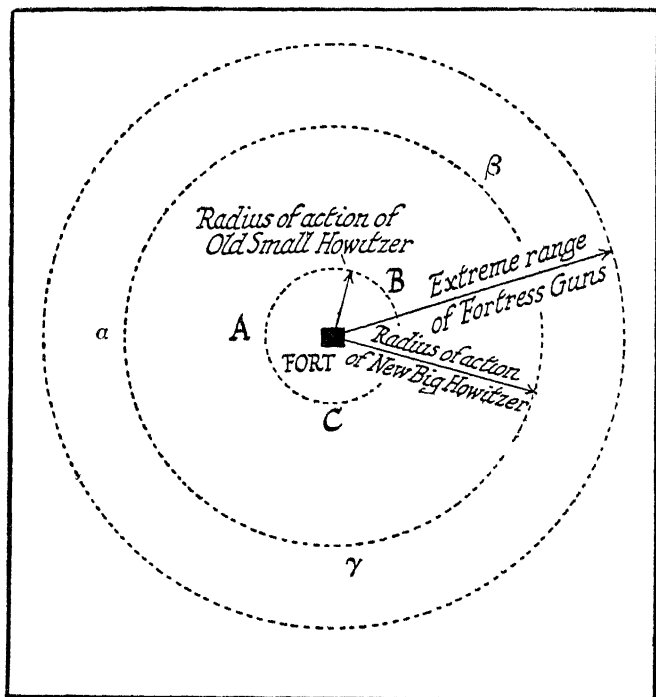

Sketch 20.

extremely small. Secondly, because the explosives used, even when they landed and during the short time that the howitzer remained undiscovered and unheard, were

not sufficiently powerful nor, with the small howitzers then in existence, sufficiently large in amount in each shell to destroy permanent fortification. Thirdly, because the effect of the aim is always doubtful. You are firing at something well above yourself, and you could not tell very exactly where your howitzer shell had fallen.

What has modified all this in the last few years is—

First, the successful bringing into the field of very large howitzers, which, though they do lob their shells, lob them over a very great distance. The Austrians have produced howitzers of from 11 to 12 inches in calibre, which, huge as they are, can be moved about in the field and fired from any fairly steady ground; and the Germans have probably produced (though I cannot find actual proof that they have used them with effect) howitzers of more than 16 inches calibre, to be moved, presumably, only upon rails. But 11-inch was quite enough to change all the old conditions. It must be remembered that a gun varies as the *cube* of its calibre. A 12-inch piece is not twice as powerful as a 6-inch. It is *eight times* as powerful. The howitzer

could now fire from an immense distance. The circumference on which it worked was very much larger; its opportunities for finding suitable steep cover far greater. Its opportunities for moving, if it was endangered by being spotted, were also far greater; and the chances of the gun in the fortress knocking it out were enormously diminished.

Secondly, the high explosives of recent years, coupled with the vast size of this new mobile howitzer shell, is capable, when the howitzer shell strikes modern fortification, of doing grievous damage which, repeated over several days, turns the fort into a mass of ruins.

Thirdly, the difficulty of accurate aiming over such distances and of locating your hits so that they destroy the comparative small area of the fort is got over by the use of aircraft, which fly above the fort, note the hits, and signal the results.

Now, the Germans maintained that under these quite recently modified conditions not even the best handled and heaviest gunned permanent fort could hold out more than a few days. The French believed that it could, and they trusted in

the stopping power not only of individual works (such as the fortress of Manonvilliers on the frontier), but more especially of great rings of forts, such as surround Liége, Namur, Verdun, etc., and enclose an area within the security of which large bodies of troops can be held ready, armies which no one would dare to leave behind them without having first reduced them to surrender.

The very first days of the war proved that the German theory was right and the French wrong. The French theory, upon which such enormous funds had been expended, had been perfectly right until within quite recent years the conditions had changed. Port Arthur, for instance, only ten years ago, could hold out for months and months. In this war no individual fort has held out for more than eleven days.

It might be imagined under such circumstances that the very existence of fortresses was doomed; yet we note that Verdun continues to make a big bulge in the German line four months after the first shots fell on its forts, and that the Germans are actively restoring the great

Belgian rings they have captured at Liége, Antwerp, and Namur.

Why is this? It is because another German theory has proved right in practice.

III. This German theory which has proved right in practice is what may be called "the mobile defence of a fortress." It proposes no longer to defend upon expensive permanent works precisely located upon the map, but upon a number of improvised batteries in which heavy guns can move somewhat behind field-works concealed as much as possible, numerous and constructed rapidly under the conditions of the campaign. Such works dotted round the area you desire to defend are quite a different thing to reduce from isolated, restricted, permanent forts. In the first place, the enemy does not know where they are; in the second place, you can make new ones at short notice; in the third place, if a howitzer does spot your heavy gun, you can move it or its neighbours to a new position; in the fourth place, the circumference you are defending is much larger, and the corresponding area that the besiegers have to search

with their fire more extended. Thus, in the old forts round Verdun, about a dozen permanent works absolutely fixed and ascertainable upon the map, and covering altogether but a few acres, constituted the defence of the town. Before September was out the heavy guns had been moved to trenches far advanced into the field to the north and east, temporary rails had been laid down to permit their lateral movement—that is, to let them shift from a place where they had perhaps been spotted to a new place, under cover of darkness, and the sectors thus thrown out in front of the old fortifications in this improvised mobile fashion were at least three times as long as the line made by the ring of old forts, while the area that had to be searched was perhaps a hundred times as large. For in the place of the narrowly restricted permanent fort, with, say, ten heavy guns, you had those same ten heavy guns dotted here and there in trenches rapidly established in half a dozen separate, unknown, and concealed spots, along perhaps a mile of wooded hill, and free to operate when moved over perhaps double that front.

IV. *In Grand Strategy a German general theory of strategics was opposed to a French general theory of strategics, and upon which of the two should prove right depended, much more than on any of the previous points, the ultimate issue of the campaign.*

This is far the most important point for the reader's consideration. It may be said with justice that no one can understand this war who has not grasped the conflict between these two fundamental conceptions of armed bodies in action, and the manner in which (by the narrowest and most fortunate margin!) events in the first phase of the war justified the French as against the German school.

I must therefore beg the reader's leave to go somewhat thoroughly into the matter, for it is the foundation of all that will follow when we come to the narration of events and the story of the Western battle which began in the retreat from the Sambre and ended in the Battle of the Marne.

The first postulate in all military problems is that, other things being equal, numbers are the decisive factor in war. This does not mean that absolute superiority of numbers decides a campaign neces-

sarily in favour of the superior power. What it means is that *in any particular field*, if armament and discipline are more or less equal on the two sides, the one that has been able to mass the greater number *in that field* will have the victory. He will disperse or capture his enemy, or at the least he will pin him and take away his *initiative*—of which word “initiative” more later. Now, this field in which one party has the superior numbers can only be a portion of the whole area of operations. But if it is what is called the decisive portion, then he who has superior numbers *in the decisive time and place* will win not only there but everywhere. His local victory involves consequent success along the whole of his line.

For instance, supposing five men are acting against three. Five is more than three; and if the forces bear upon each other equally, the five will defeat the three. But if the five are so badly handled that they get arranged in groups of two, two, and one, and if the three are so well handled that they strike swiftly at the first isolated two and defeat them, thus bringing up the next isolated two, who are

in their turn defeated, the three will, at the end of the struggle, have only one to deal with, and the five will have been beaten by the three because, although five is larger than three, yet *in the decisive time and place* the three never have more than two against them. It may be broadly laid down that the whole art of strategics consists for the man with superior numbers in bringing all his numbers to bear, and for the man with inferior numbers in attempting by his cunning to compel his larger opponent to fight in separated portions, and to be defeated in detail.

As in every art, the developments of these elementary first principles become, with variations of time and place, indefinitely numerous and various. Upon their variety depends all the interest of military history. And there is one method in particular whereby the lesser number may hope to pin and destroy the power of the greater upon which the French tradition relied, and the value of which modern German criticism refused.

Before going into that, however, we must appreciate the mental qualities which led to the acceptance of the theory upon

the one side and its denial upon the other.

The fundamental contrast between the modern German military temper and the age-long traditions of the French service consists in this: That the German theory is based upon a presumption of superiority, moral, material, and numerical. The theory of the French—as their national temperament and their Roman tradition compel them—is based upon an *envisagement* of inferiority: moral, material, and numerical.

There pervades the whole of the modern German strategic school this feeling: “I shall win if I act and feel as though I was bound to win.” There pervades the whole French school this sentiment: “I have a better chance of winning if I am always chiefly considering how I should act if I found myself inferior in numbers, in material, and even in moral at any phase in the struggle, especially at its origins, but even also towards its close.”

This contrast appears in everything, from tactical details to the largest strategical conception, and from things so vague and general as the tone of military writings, to things so particular as the

instruction of the conscript in his barrack-room. The German soldier is taught—or was—that victory was inevitable, and would be as swift as it would be triumphant: the French soldier was taught that he had before him a terrible and doubtful ordeal, one that would be long, one in which he ran a fearful risk of defeat, and one in which he might, even if victorious, have to wear down his enemy by the exercise of a most burdensome tenacity. In the practice of the field, the contrast appeared in the French use of a great reserve, and the German contempt for such a precaution: in the elaborate thinking out of the use of a reserve, which is the core of French military thought; in the superficial treatment of the same, which is perhaps the chief defect of Germany.

It would be of no purpose to debate here which of these two mental attitudes, with all their consequences, is either morally the better or in practice the more successful. The French and Latin tradition seems to the German pusillanimous, and connected with that decadence which he perceives in every expression of civilization from Athens to Paris. The modern

German conception seems to the French theatrical, divorced from reality, and hence fundamentally weak. Either critic may be right or either wrong. Our interest is to follow the particular schemes developing from that tone of mind. We shall see how, in the first phases of the war, the German conception strikingly justified itself for more than ten days; how, after a fortnight, it was embarrassed by its opponent; and how at the end of a month the German initiative was lost under the success—only barely achieved after dreadful risk—of the French plan.

That plan, inherited from the strategy of Napoleon, and designed in particular to achieve the success of a smaller against a larger number, may be most accurately defined as *the open strategic square*, and its leading principle is “the method of detached reserves.”

This strategic conception, which I shall now describe, and which (in a diagram it is put far too simply) underlies the whole of the complicated movements whereby the French staved off disaster in the first weeks of the war, is one whose whole object it is to permit the inferior number to

bring up a *locally* superior weight against a *generally* superior enemy in the decisive time and at the decisive place.

Let us suppose that a general commanding *twelve* large units—say, twelve army corps—knows that he is in danger of being attacked by an enemy commanding no less than *sixteen* similar units.

Let us call the forces of the first or weaker general “White,” and those of the second or stronger general “Black.”

It is manifest that if White were merely to deploy his line and await the advance of Black thus,

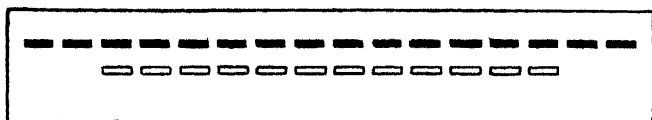

Sketch 21.

he would be outflanked and beaten; or, in the alternative, Black might mass men against White's centre and pierce it, for Black is vastly superior to White in numbers. White, therefore, must adopt some special disposition in order to avoid immediate defeat.

Of such special dispositions one among many is the French Open Strategic Square.

This disposition is as follows :—

White arranges his twelve units into four quarters of three each, and places one quarter at each corner of a square thus :—

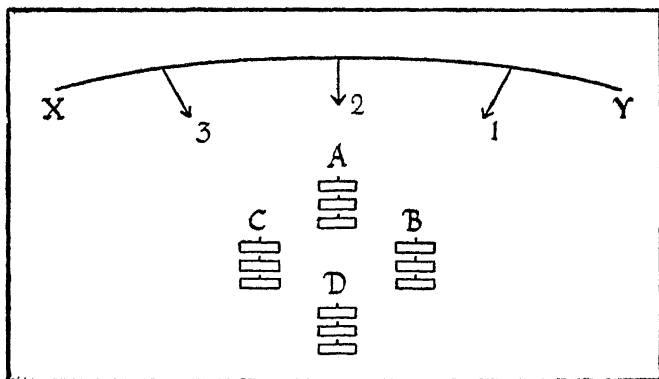

Sketch 22.

We will give them titles, and call them A, B, C, and D.

If, as is most generally the case in a defensive campaign at its opening, White cannot be certain from which exact direction the main blow is coming, he may yet know that it is coming from some one general direction, from one sector of the compass at least, and he arranges his square to face towards that sector.

For instance, in the above diagram, he may not know whether the blow is coming

from the precise direction 1, or 2, or 3, but he knows that it is coming somewhere within the sector XY.

Then he will draw up his square so that its various bodies all face towards the average direction from which the blow may come.

The SIZE of his square—which is of great importance to the result—he makes as restricted as possible, *subject to two prime conditions*. These conditions are :—

First, that there shall be room for the troops composing each corner to be deployed—that is, spread out for fighting. Secondly, that there shall be room between any two corners (A and C, for instance) for a third corner (D, for instance) to move in between them and spread out for fighting in support of them. He makes his square as close and restricted as possible, because his success depends—as will be seen in a moment—upon the rapidity with which any one corner can come up in support of the others. But he leaves enough room for the full numbers to spread out for fighting, because otherwise he loses in efficiency ; and he leaves room enough between any two squares for a third one to come in,

because the whole point of the formation is the aid each corner can bring to the others.

In this posture he awaits the enemy.

That enemy will necessarily come on in a lengthy line, lengthy in proportion to the number of his units. For it is essential to the general commanding *superior* numbers to make the *whole* of the superior numbers tell, and this can only be done if

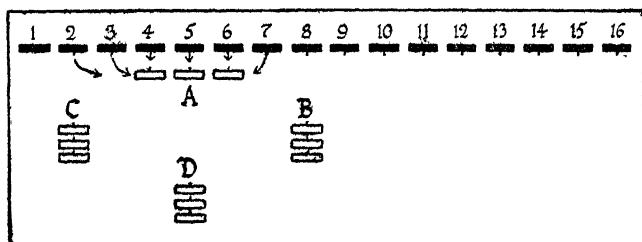

Sketch 23.

they march along parallel roads, and these roads are sufficiently wide apart for the various columns to have plenty of room to deploy—that is, to spread out into a fighting line—when the shock comes.

This extended line of Black marching thus against White strikes White first upon some one corner of his square. Suppose that corner to be corner A. Then the position when contact is established and

the first serious fighting begins is what you will observe in the above diagram. A is the corner (now spread out for fighting) which gets the first shock.

Note you (for this is the crucial point of the whole business) that upon the exposed corner A will fall a very dangerous task indeed. A will certainly be attacked by forces superior to itself. Normally forces more than half as large again as A will be near enough to A to concentrate upon him in the first shock. The odds will be at least as much as five to three, the Black units, 4, 5, and 6, will be right on A, and 3 and 7 will be near enough to come in as well in the first day or two of the combat, while possibly 2 may have a look in as well.

A, thus tackled, has become what may be called "the *operative corner* of the square." It is his task "to retreat and hold the enemy" while B, C, and D, "the masses of manœuvre," swing up. But under that simple phrase "operative corner" is hidden all the awful business of a fighting retreat: it means leaving your wounded behind you, marching night and day, with your men under the impression

of defeat; leaving your disabled guns behind you, keeping up liaison between all your hurrying, retreating units, with a vast force pressing forward to your destruction. A's entire force is deliberately imperilled in order to achieve the success of the plan as a whole, and upon A's tenacity, as will be seen in what follows, the success of that plan entirely depends.

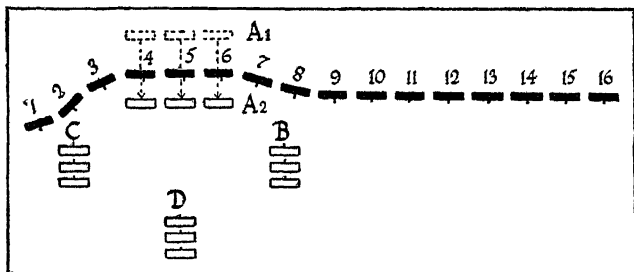

Sketch 24.

Well, while A is thus retreating—say, from his old position at A_1 on the foregoing diagram to such a position as A_2 , with Black swarming up to crush him—the other corners of the square, B, C, and D, receive the order to “swing”—that is, to go forward inclining to the left or the right according to the command given.

Mark clearly that, until the order is given, the general commanding Black can-

192 A GENERAL SKETCH OF

not possibly tell whether the “swing” will be directed to the left or to the right. Either B will close up against A, C spread out farther to the left, and D come in between A and C (which is a “swing” to the left) as in Sketch 25, or C will close up against A, B will spread well out to the right, and D come up between A and

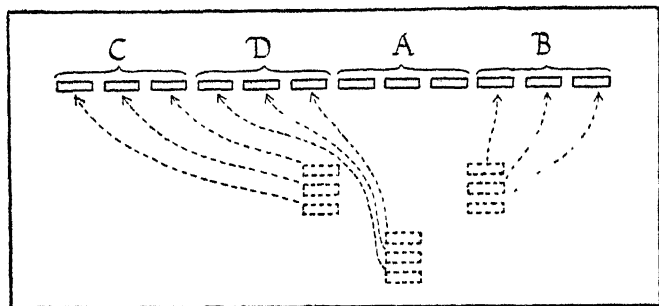

Sketch 25.

B, as in Sketch 26 (which is a “swing” to the right).

Until the “swing” actually begins, Black, the enemy, cannot possibly tell whether it is his left-hand units (1 to 8) or his right-hand units (9 to 16) which will be affected. One of the two ends of his line will have to meet White’s concentrated effort; the other will be left out in the cold. Black cannot make disposi-

tions on the one hypothesis or on the other. Whichever he chose, White would, of course, swing the other way and disconcert him.

Black, therefore, has to keep his line even until he knows which way White is going to swing.

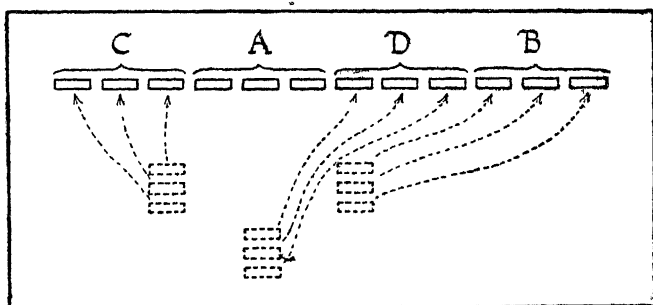

Sketch 26.

Let us suppose that White swings to the left.

Mark what follows. The distances which White's units have got to go are comparatively small. B will be up at A's side, and so will D in a short time after the swing is over, and when the swing is completed, the position is after this fashion. Black's numbers, 1 to 9 inclusive, find themselves tackled by all Black's twelve. There is a superiority of number against

Black on his right, White's left, and the remaining part of Black's line (10 to 16 inclusive), is out in the cold.

If it were a tactical problem, and all this were taking place in a small field, Black's left wing, 10-16, would, of course, come up at once and redress the balance. But being a strategical problem, and involving very large numbers and very great distances, Black's left wing, 10-16, can do

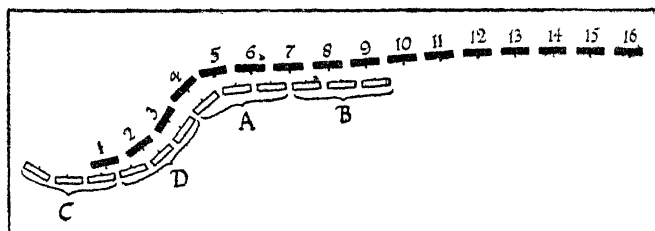

Sketch 27.

nothing of the kind. For Black's left wing, 10-16, *cannot possibly get up in time*. Long before it has arrived on the scene, White's 12 will have broken Black's 9 along Black's right wing.

There are three elements which impose this delay upon Black's left wing.

First, to come round in aid of the right wing means the marching forward of one unit after another, so that each shall over-

lap the last, and so allow the whole lot to come up freely. This means that the last unit will have to go forward six places before turning, and that means several days' marching. For with very large bodies, and with a matter of 100 miles to come up, all in one column, it would be an endless business (Sketch 28).

Next you have the delay caused by the

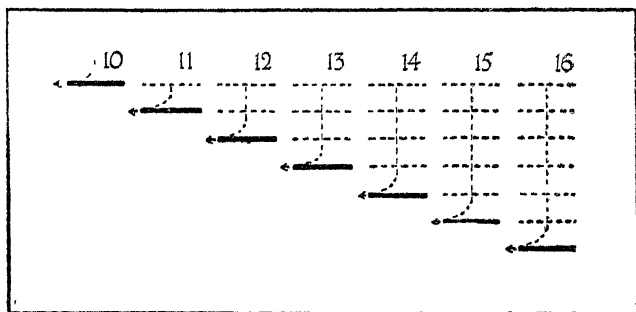

Sketch 28.

conversion of direction through a whole right angle. That cause of delay is serious. For when you are dealing with very large bodies of men, such as half a dozen army corps, to change suddenly from the direction S (see Sketch 29) for which your Staff work was planned, and to break off at a moment's notice in direction E, while you are on the march towards S, is impossible.

196 A GENERAL SKETCH OF

You have to think out a whole new set of dispositions, and to re-order all your great body of men. White was under no such compulsion, for though he had to swing, the swing faced the same general direction as his original dispositions. And the size of the units and the distances to be traversed—the fact that the problem is

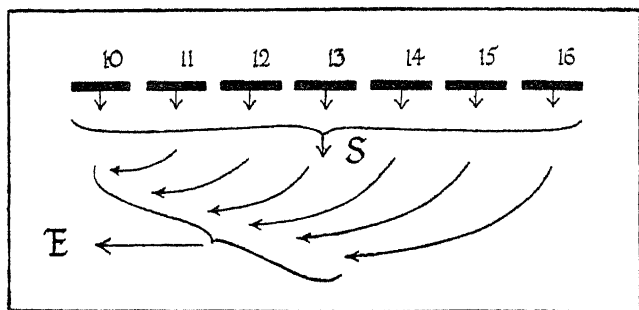

Sketch 29.

strategical and not tactical—is the essence of the whole thing. If, for instance, you have (as in Sketch 30) half a dozen, not army corps, but mere battalions of 1,000 men, deployed over half a dozen miles of ground, AB, and advancing in the direction SS, and they are suddenly sent for in the direction E, it is simple enough. You form your 6,000 men into column; in a few hours' delay they go off in the direction E,

and when they get to the place where they are wanted, the column can spread out quickly again on the front CD, and soon begin to take part in the action. But when you are dealing with half a dozen army corps—240,000 men—it is quite another

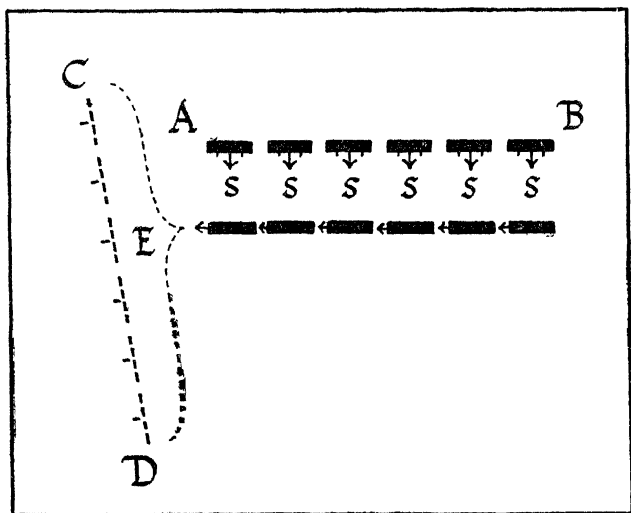

Sketch 30.

matter. The turning of any one of these great bodies through a whole right angle is a lengthy business. You cannot put a quarter of a million men into one column—they would take ages to deploy—so you must, as we have seen, make each unit of them overlap the next before the turn can begin.

Nor is that all the delay involved. It would never do for these six separate corps to come up in dribblets and get defeated in detail ; 10, 11, and 12 will have to wait until 13, 14, 15, and even 16, have got up abreast of them—and that is the third cause of delay.

Here are three causes of delay which, between them and accumulated, have disastrous effect ; and in general we may be certain that where very large bodies and very extensive stretches of territory are concerned, that wing of Black which has been left out in the cold can never come up in time to retrieve the situation created by White's twelve pinning Black's engaged wing of only nine.

If the square has worked, and if the twelve White have pinned the right-hand wing of Black, 1 to 9 inclusive, there is nothing for Black to do but to order his right wing, 1 to 9, to retreat as fast as possible before superior numbers, and to order his left wing, 10 to 16, to fall back at the same time and keep in line ; and you then have the singular spectacle of twelve men compelling the retreat of and pursuing sixteen.

That is exactly what happened in the first three weeks of active operations in the West. The operative corner A in the annexed diagram was the Franco-British force upon the Sambre. The retirement of that operative corner and its holding of the enemy was what is called in this country "The Retreat

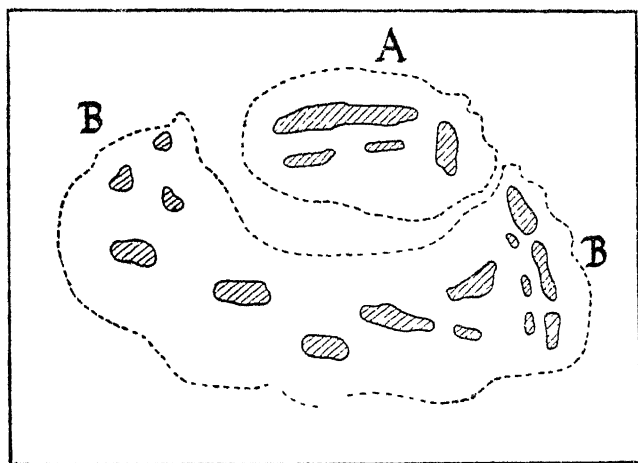

Sketch 31.

from Mons." BB are the "masses of manoeuvre" behind A. The swinging up of these masses involving the retirement of the whole was the Battle of the Marne.

Now, it is evident that in all this everything depends upon the tenacity and military value of the operative corner, which

is exposed and sacrificed that the whole scheme of the Open Square may work.

If that operative corner is destroyed as a force—is overwhelmed or dispersed or surrounded—while it is fighting its great odds, the whole square goes to pieces. Its centre is penetrated by the enemy, and the army is in a far worse plight than if recourse had never been had to the open strategic square at all. For if the operative corner, A, is out of existence before the various bodies forming the “manœuvring mass” behind it have had time to “swing,” then the enemy will be right in their midst, and destroying, in overwhelming force, these remaining *separated* bodies in detail.

It was here that the German strategic theory contrasted so violently with the French. The Germans maintained that an ordeal which Napoleon might have been able to live through with his veterans and after fifteen years of successful war, a modern conscript army, most of its men just taken from civilian life and all of short service, would never endure. They believed the operative corner would go to pieces and either be pounded to disintegration, or outflanked, turned, and caught in

the first days of the shock before the rest of the square had time to "work." The French believed the operative corner would stand the shock, and, though losing heavily, would remain in being. They believed that the operative corner of the square would, even under modern short service and large quasi-civilian reserve conditions, remain an army. They staked their whole campaign upon that thesis, and they turned out to be right. But they only just barely won through, and by the very narrowest margin. Proving right as they did, however, the success of their strategical theory changed the whole course of the war.

With this contrast of the great opposing theories considered, I come to the conclusion of my Second Part, which examines the forces opposed. I will now turn to the Third Part of my book, which concerns the first actual operations from the Austrian note to the Battle of the Marne.

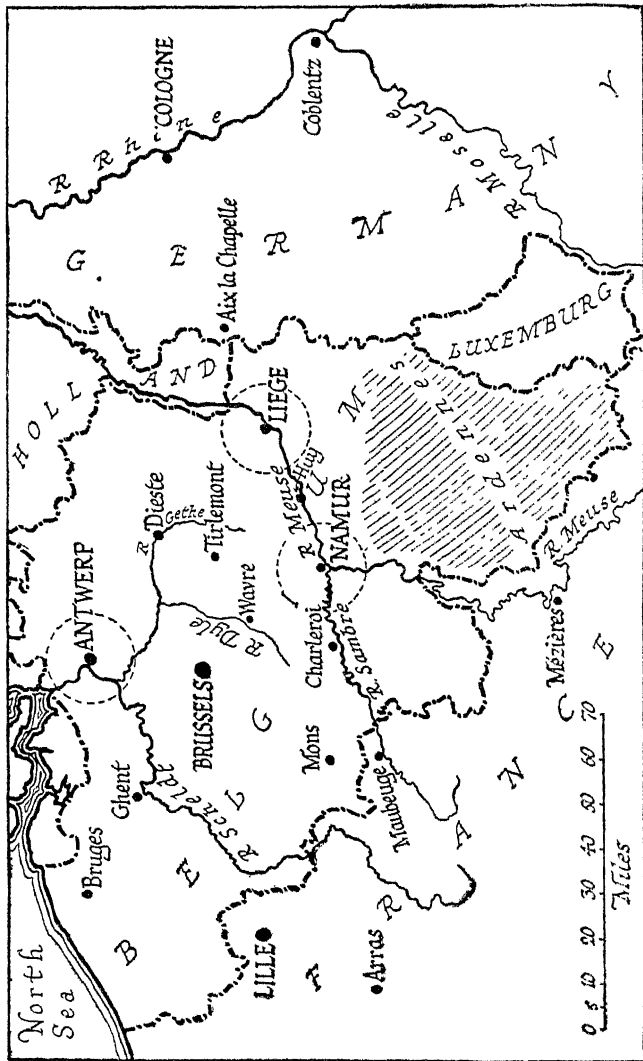

Sketch 32

PART III.

THE FIRST OPERATIONS.

IN any general view of the great war which aims both at preserving proportion between its parts, and at presenting especially the main lines in relief, the three weeks between the German sudden forcing of war and the seventeen or eighteen days between the English declaration and the main operations upon the Sambre, will have but a subsidiary importance. They were occupied for at least half the period in the mobilization of the great armies. They were occupied for the second half of the period in the advance across the Rhine of German numbers greatly superior to the Allies, and also through the plain of Northern Belgium. The operation, as calculated by the German General Staff, was delayed by but a very few days—one might almost say hours—

by the hastily improvised resistance of Liége, and the imperfect defence of their country which was all the Belgian forces, largely untrained, could offer.

We must, therefore, pass briefly enough over that preliminary period, though the duty may be distasteful to the reader, on account of the very exaggerated importance which its operations took, especially in British eyes.

For this false perspective there were several reasons, which it is worth while to enumerate, as they will aid our judgment in obtaining a true balance between these initial movements and the great conflicts to which they were no more than an introduction.

1. War, as a whole, had grown unfamiliar to Western Europe. War on such a scale as this was quite untried. There was nothing in experience to determine our judgment, and after so long a peace, during which the habits of civil life had ceased to be conventioned and had come to seem part of the necessary scheme of things, the first irruption of arms dazzled or confounded the imagination of all.

2. The first shock, falling as it did upon

the ring fortress of Liége, at once brought into prominence one of the chief questions of modern military debate, the value of the modern ring fortress, and promised to put to the test the opposing theories upon this sort of stronghold.

3. The violation of Belgian territory, though discounted in the cynical atmosphere of our time, when it came to the issue was, without question, a stupendous moral event. It was the first time that anything of this sort had happened in the history of Christian Europe. Historians unacquainted with the spirit of the past may challenge that remark, but it is true. One of the inviolable conventions, or rather sacred laws, of our civilization was broken, which is that European territory not involved in hostilities by any act of its Government is inviolable to opposing armies. The Prussian crime of Silesia, nearly two centuries before, the succeeding infamies of 1864, and the forgery of the Ems dispatch, the whole proclaimed tradition of contempt for the sanctities of Christendom, proceeding from Frederick the Great, had indeed accustomed men to successive stages in the decline of inter-

national morals ; but nothing of the wholly crude character which this violation of Belgium bore was to be discovered in the past, even of Prussia, and posterity will mark it as a curious term and possibly a turning-point in the gradual loss of our common religion, and of the moral chaos accompanying that loss.

4. The preparations of this country by land were not complete. Those of the French were belated compared with those of the Germans, and the prospect of even a short delay in the falling of the blow was exaggerated in value by all the intensity of that anxiety with which the blow was awaited.

To proceed from these preliminaries to the story.

The German Army had for its ultimate object, when it should be fully mobilized, the passage of the greater part of its forces over the Belgian Plain.

This Belgian Plain has for now many centuries formed the natural avenue for an advance upon the Gauls.

It has been represented too often as a

sort of meeting-place, where must always come the shock between what is called Latin civilization and the Germanic tribes. But this view is both pedantic and historically false. There never was here a shock or conflict between two national ideals. What is true is, that civilization spread far more easily up from the Gauls through that fertile land towards the forests of Germany, and that when the Roman Empire broke down, or rather when its central government broke down, the frontier garrisons could here depend upon wealthier and more numerous populations for the support of their local government. That body of auxiliary soldiers in the Roman army which was drawn from the Frankish tribes ruled here when Rome could no longer rule. It was from Tournai that the father of Clovis exercised his power; and in the resettlement of the local governments in the sixth century, the Belgian Plain was the avenue through which the effort of the civilized West was directed towards the Rhine. It has Roman Cologne for its outpost; later it evangelized the fringes of German barbarism, and later still conquered them

with the sword. All through the succeeding centuries the ambitions of kings in France, or of emperors upon the Rhine, were checked or satisfied in that natural avenue of advance. Charlemagne's frontier palace and military centre facing the Pagans was rather at Aix than at Trèves or Metz; and though the Irish missionaries, who brought letters and the arts and the customs of reasonable men to the Germans, worked rather from the south, the later forced conversion of the Saxons, which determined the entry of the German tribes as a whole into Christendom, was a stroke struck northwards from the Belgian Plain. Cæsar's adventurous crossing of the Rhine was a northern crossing. The Capetian monarchy was saved on its eastern front at Bouvines, in that same territory. The Austro-Spanish advance came down from it, to be checked at St. Quentin. Louis XIV.'s main struggle for power upon the marches of his kingdom concentrated here. The first great check to it was Marlborough's campaign upon the Meuse; the last battle was within sound of Mons, at Malplaquet. The final decision, as it was hoped—the

defeat of Napoleon at Waterloo—again showed what this territory meant in the military history of the West. It was following upon this decision that Europe, in the great settlement, decided to curb the chaos of future war by solemnly neutralizing the Belgian Plain for ever; and to that pact a seal was set not only by the French and the British, but also by the Prussian Government, with what results we know.

The entries into this plain are very clearly defined by natural limits. It is barred a few hours' march beyond the German frontier by the broad and deep river Meuse, which here runs from the rough and difficult Ardennes country up to the Dutch frontier. The whole passage is no more than twelve miles across, and at the corner of it, where the Meuse bends, is the fortress of Liége. West of this fortress the upper reaches of the river run, roughly east and west upon Namur, and after Namur turn south again, passing through a very deep ravine that extends roughly from the French town of Mezières to Namur through the Ardennes country. The Belgian Plain is therefore like a bottle

210 A GENERAL SKETCH OF

with a narrow neck, a bottle defined by the Dutch frontier and the Middle Meuse on either side, and a neck extending only from the Ardennes country to the Dutch frontier, with the fortress of Liège barring the way. Now the main blow was to be delivered ultimately upon the line Namur-Charleroi-Mons. That is, the situation

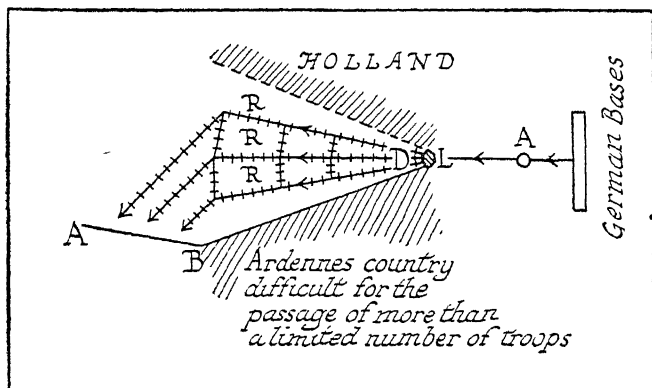

Sketch 33.

was roughly that of the accompanying diagram: by the bottle neck at D the whole mass of troops must pass—or most of them—which are later to strike on the front AB. To reach that front was available to the invader the vast network of Belgian railways RRR crammed with rolling stock, and provided such op-

portunities for rapid advance as no other district in Europe could show. But all this system converged upon the main line which ran through the ring of forts round Liège, L, and so passed through Aix-la-Chapelle, A, and to Germany.

The German Government, therefore, could not be secure of its intention to pass great bodies through the Belgian Plain until Liège was grasped, and it was determined to grasp Liège long before the mobilization of the German forces was completed. For this purpose only a comparatively small force, rapidly gathered, was available. It was placed under the command of General von Emmerich, and its first bodies exchanged shots with the Belgian outposts early in the afternoon of Tuesday, August 4, 1914.

The hour and date should always be remembered for the solemnity which attaches to the beginning of any great thing; and the full observer of European affairs, who understands what part religion or superstition plays in the story of Europe, will note this enormously significant detail. The first Germans to cross the violated frontier accomplished that act upon

the same day and at the same hour as that in which their forerunners had crossed the French frontier forty-four years before.

The afternoon wore on to night, with no more than a conflict between outposts. Just before midnight the cannonade was first heard. It also was the moment in which the ultimatum delivered to Germany by this country, by a coincidence, expired.*

This night attack with guns was only delivered against one sector of the Liège forts, and only with field-pieces.

As to the first of these points, it will be found repeated throughout the whole of the campaign wherever German forces attack a ring of permanent works. For the German theory in this matter (which experience has now amply supported) is that since modern permanent works *of known and restricted position* go under to a modern siege train if the fire of the latter be fully concentrated and the largest pieces available, everything should be sacrificed to the putting into the narrowest

* The ultimatum expired at midnight (August 4-5) by Greenwich time, 11 p.m. (August 4) by German, or Central European, time.

area of all the projectiles available. The ring once broken on a sufficient single sector point is broken altogether.

The second point, that only field-pieces as yet were used (which was due to the fact that the siege train was not yet come up), is an important indication of the weakness of the defence—on all of which the enemy were, of course, thoroughly informed.

There were perhaps 20,000 men in and upon the whole periphery of Liège, a matter of over thirty miles, and what was most serious, no sufficient equipment or preparation of the forts, or, what was more serious still, no sufficient trained body of gunners.

It is almost true to say that the resistance of Liège, such as it was, was effected by rifle fire.

With the dawn of August 5th, and in the first four hours of daylight, a German infantry attack upon the same south-eastern forts which had been subjected to the first artillery fire in the night developed, and after some loss withdrew, but shortly after the first of the forts, that of Fléron, was silenced. The accompanying sketch map will show how wide a gap was left

henceforward in the defences. Further, Fléron was the strongest of the works upon this side of the river. Seeing that,

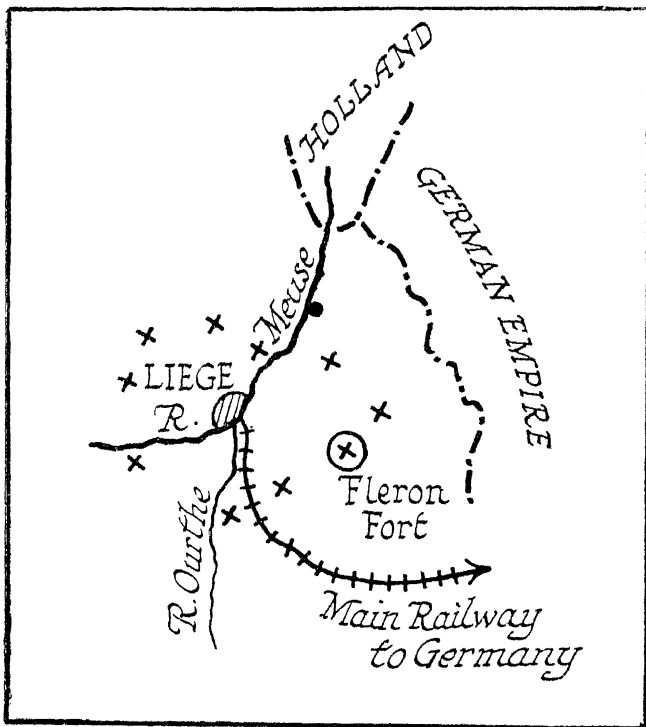

Sketch 34.

in any case, even if there had been a sufficient number of trained gunners in the forts, and a sufficient equipment and full preparation of the works for a siege (both

of which were lacking), the absence of sufficient men to hold the gaps between would in any case have been fatal to the defence. With such a new gap as this open by the fall of Fléron, the defence was hopeless, even if it were only to be counted in hours.

It is high praise of the Belgian people and character to point out that, after the fall of Fléron, for forty-eight full hours such a gap was still contested by men, a great part of whom were little better than civilian in training, and who, had they been all tried regulars, would have been far too few for their task. General Leman, who commanded them, knew well in those early hours of Wednesday, the 5th, that the end had already come. He also knew the value of even a few hours' hopeless resistance, not perhaps to the material side of the Allied strategy, but to the support of those moral forces lacking which men are impotent in maintaining a challenge. Not only all that Wednesday, the 5th, but all the Thursday, the 6th, he maintained a line against the pressure of the invaders with his imperfect and insufficient troops.

During those forty-eight hours, the big

howitzer, which is the type of the heavy German siege train—the 225 mm.—was brought up, and it is possible that a couple of the still larger Austrian pieces of 280 mm. (what we call in this country the 11-inch), which are constructed with flat treadles to their wheels to fire from mats laid on any reasonably hard surface (such as a roadway), had been brought up as well. At any rate, in the course of the Thursday, the fort next westward from Fléron, Chaudfontaine, was smashed. The gap was now quite untenable, and the first body of German cavalry entered the city. The incident has been reported as a *coup de main*, with the object of capturing the Belgian general. Its importance to the military story is simply that it proved the way to be open. In the afternoon and evening of the day, the Belgians were retiring into the heart of the city, and it is typical of the whole business that the great railway bridge upon which the main communications depended was left intact for the Germans to use.

With the morning of Friday, the 7th August, the first bodies of German infantry entered the town. The forts on

the north and two remaining western forts upon the south of the river were still un-taken, and until a large breach should be made in the northern forts at least, the railway communication of the German advance into the Belgian plain was still impeded. Great masses of the enemy, and, in proportion to those masses, still greater masses of advance stores were brought in.

In all that follows, until we reach the date of Monday, August 24th, I propose to consider no more than the fortunes of the troops who passed through Belgium to attack the French armies upon the Sambre and the Meuse, with the British contingent that had come to their aid. And my reasons for thus segregating and dealing later with contemporary events in the south will appear in the sequel.

This reservation made—an important one in the scheme of this book—I return to what I have called the preliminaries, the advance through Belgium.

We have already seen that the reduction of the northern forts of Liége was the prime necessity to that advance.

We have also seen that meanwhile it was

possible and advisable to accumulate stores for the advance as far forward as could be managed, and that it was also possible, with caution, to bring certain bodies—not the bulk of the army—forward through the Ardennes, to command the passages of the Meuse above Liège, between that fortress and Namur.

This latter operation was effected by the 12th of August, when the town of Huy, with its bridge and its railway leading from the Belgian Ardennes right into the Belgian Plain, was seized.

Meanwhile, upon the north of the river Meuse, cavalry and armed motor-cars were similarly preparing the way for the general advance when the northern forts of Liège should be dominated; and on this same Wednesday, August 12th, the most advanced bodies of the invader lay in a line roughly north and south from the neighbourhood of Diest along the Gethe and thence towards Huy.

Of the outrages committed upon the civilian inhabitants in all these countries, the Government of which was neutral, and the territory of which was by the public law of Europe free not only

from such novel crimes but from legitimate acts of war, I shall not speak, just as I shall not allude, save where they happen to have military importance, to the future increase of similar abominations which marked the progress of the campaign. For my only object in these pages is to lay

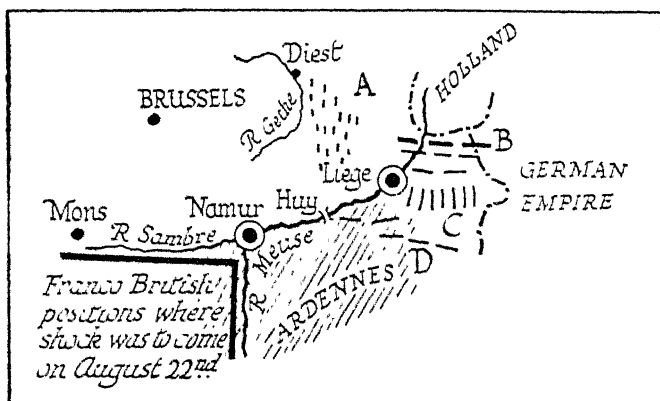

Sketch 35.

before the reader a commentary which will explain the general strategy of the war.

While this advance line of cavalry was engaging in unimportant minor actions, or rather skirmishes (grossly exaggerated in the news of those days), the attack on the northern forts of Liège, upon which everything now depended, was opened. It was upon Thursday, August 13th, that the

280 mm. howitzers opened upon Loncin. Other of the remaining forts were bombarded; but, as in the case of Fléron a week before, we need not consider the subsidiary operations, because everything depended upon the fort of Loncin, which, as the accompanying diagram shows, com-

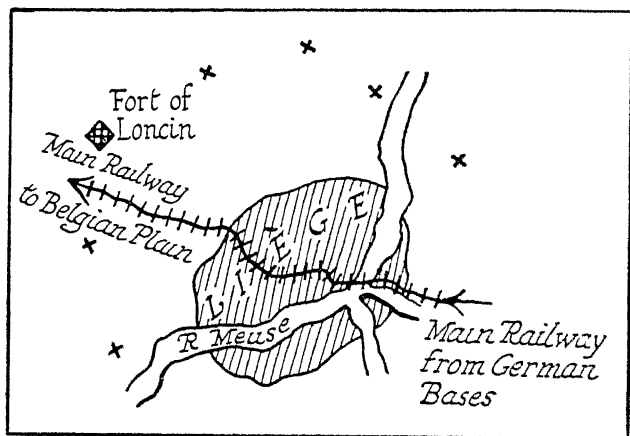

Sketch 36.

manded the railway line westward from Liège. General Leman himself was within that work, the batteries against which were now operating from *within* the ring—that is, from the city itself, or in what soldiers technically call “reverse”—that is, from the side upon which no fort is expected to stand, the side which is ex-

pected to defend and not to be attacked from. Whether Loncin held out the full forty-eight hours, or only forty, or only thirty-six, we do not know; but that moral factor to which I have already alluded, and which must be fully weighed in war, was again strengthened by the nature of such a resistance. For nearly all that garrison was dead and its commander found unconscious when the complete destruction of the work by the high explosive shells permitted the enemy to enter.

It was upon Saturday, the 15th of August, that the great bulk of the two main German armies set aside for passage through the Belgian Plain began to use the now liberated railway, and the week between that date and the first great shock upon the Sambre is merely a record of the almost uninterrupted advance, concentration, and supply of something not far short of half a million men coming forward in a huge tide over, above, and round on to, the line Namur-Charleroi-Mons, which was their ultimate objective, and upon which the Anglo-French body—perhaps half as numerous—had determined to stand.

222. A GENERAL SKETCH OF

The story of that very rapid advance is merely one of succeeding dates. By the 17th the front was at Tirlemont, by the 19th it was across the Dyle and running thence south to Wavre (the first army), the second army continuing south of this

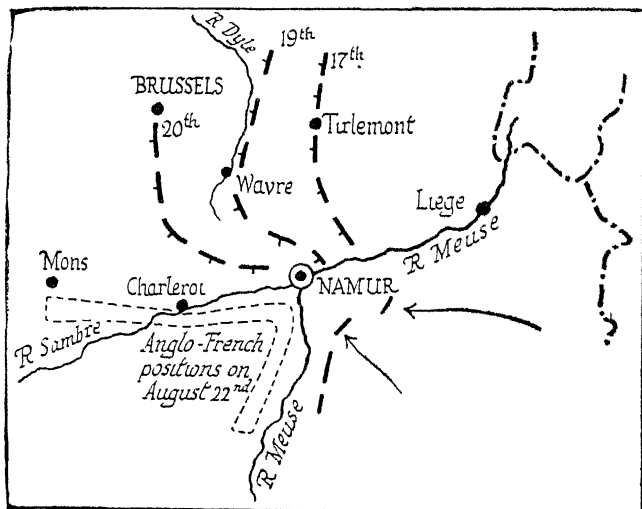

Sketch 37.

with a little east in it to a point in front of Namur. On the 20th there was enacted a scene of no military importance (save that it cost the invaders about a day), but of some moral value, because it strongly impressed the opinion in this country and powerfully affected the imagination of

Europe as a whole : I mean the triumphal march through Brussels.

Far more important than this display was the opening on the evening of the same day, Thursday, August 20th, of the first fire against the eastern defences of Namur. This fire was directed upon that evening against the two and a half miles of trench between the forts of Cognelée and Marchovette, and in the morning of Friday, the 21st, the trenches were given up, and the German infantry was within the ring of forts north of the city. The point of Namur, as we shall see in a moment, was twofold. First, its fortifications, so long as they held out, commanded the crossings both of the Sambre and of the Meuse within the angle of which the French defensive lay ; secondly, its fortified zone formed the support whereupon the whole French right reposed. It was this unexpected collapse of the Belgian defence of Namur which, coupled with the unexpected magnitude of the forces Germany had been able to bring through the Belgian plain, determined what was to follow.

Once Namur was entered, the reduction

of the forts was not of immediate importance, though it was immediately and successfully achieved. For the German business was not here, as at Liége, to grasp a railway within the zone of the fortifications, but to destroy the buttress upon which the French depended for their defensive position, and to prevent the French from holding the crossings over the two rivers Sambre and Meuse at their junction.

With this entry of the Germans into Namur, their passage of the lines upon Friday, August 21st, their capture of the bridgeheads on Saturday, August 22nd, we reach the beginning of those great operations which threatened for a moment to decide the war in the West, and to establish the German Empire in that position to attain which it had planned and forced the war upon its appointed day.

It behoves us before entering into the detail of this large affair to see the plan of it clearly before our eyes.

I have already described that general conception underlying the whole modern French school of strategy for which the best title (though one liable to abuse by

too mechanical an interpretation) is "the open strategic square."

I have further warned the reader that, in spite of the way in which the intricacy of organization inseparable from great masses and the manifold disposition of a modern army will mask the general nature of such an operation, that operation cannot be understood unless its simplest lines are clear. I have further insisted that in practice those lines remain only in the idea of the scheme of the whole, and are not to be discovered save in the loosest way from the actual positions of men upon the map.

We have seen that this "open strategic square" involved essentially two conceptions—the fixed "operative corner" and the swinging "manœuvring masses."

The manœuvring masses, at this moment when the great German blow fell upon the Sambre and the Meuse, and when Namur went down immediately before it, were (*a*) upon the frontiers of Alsace and Lorraine, (*b*) in the centre of the country, (*c*) near the capital and to the west of it, and even, some of them, upon the sea.

The operative corner was this group of

armies before Namur on the Sambre and Meuse, the 4th French Army under Langle, the 5th French Army under Lanrezac, the British contingent under French.

We know from what has been written above in this book that it is the whole business of an operative corner to "take on" superior numbers, and to hold them as well as possible, even though compelled to retreat, until the manœuvring masses can swing and come up in aid, and so pin the enemy.

We further know from what has gone before that the whole crux of this manœuvre lies in the power of the operative corner to stand the shock.

It was the business of the French in this operative corner before Namur and of their British Allies there to await and, if possible, to withstand by a careful choice of position the first shock of enemies who would certainly be numerically superior. It was the whole business of the German commanders to make the shock overwhelming, in order that the operative corner should be pounded to pieces, or should be surrounded and annihilated before the manœuvring masses could swing

up in aid. Should this destruction of the operative corner take place before the manœuvring masses behind it could swing, the campaign in the West was lost to the Allies, and the Germans pouring in between the still separated corners of the square were the masters for good.

It behoves us, therefore, if we desire to understand the campaign, to grasp how this operative corner stood, upon what defences it relied, in what force it was, what numbers it thought were coming against it, and what numbers were, as a fact, coming against it.

To get all this clear, it is best to begin with a diagram.

Suppose two lines perpendicular one to the other, and therefore forming a right angle, AB and BC. Suppose at their junction, B, a considerable zone or segment, SSS, of a circle, as shaded in the following diagram. Supposing the line AB to be protected along the outer half of it, AK, by no natural obstacle—the state of affairs which I have represented by a dotted line $a\gamma$; but suppose the second half of it, KB, should be protected by a natural obstacle, though not a very formidable one—

such as I have represented by the continuous line $\gamma\beta$. Supposing the perpendicular line BC to be protected by a really formidable natural obstacle $\beta\delta$, and supposing the shaded segment of the circle at B to represent a fortified zone (1) accessible to any one

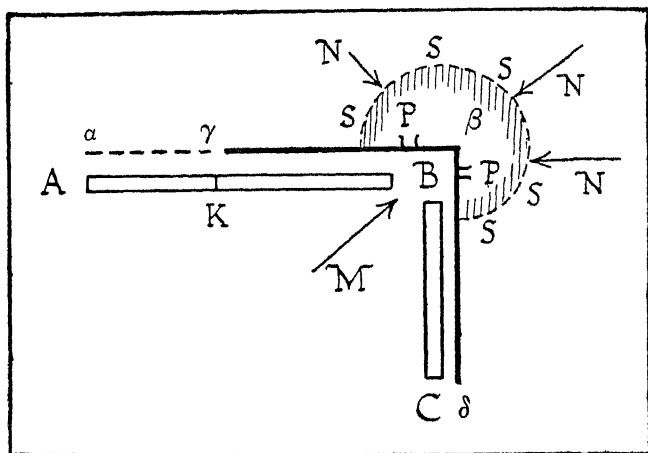

Sketch 38.

within the angle KBC, as from the arrow M; (2) inaccessible (until it was captured or forced) to any one coming from outside the angle, as from the arrows NNN; (3) containing within itself, protected by its ring of fortifications, passages, PP, for traversing the two natural obstacles, $\gamma\beta$ and $\beta\delta$, which meet at the point β .

There you have the elements of the position in which the advance corner of the great French square was situated just before it took the shock of the main German armies. The two lines AB and BC are the French and British armies lying behind the Sambre, $\gamma\beta$, and the Middle Meuse, $\beta\delta$, respectively; but the line of the Sambre ceases to protect eastward along the dotted line $a\gamma$ beyond the point up to which the river forms a natural obstacle, while from K to B the line is protected by the river Sambre itself. The more formidable obstacle, $\beta\delta$, represents the great trench or ravine of the Meuse which stretches south from Namur. The town of Namur itself is at B, the junction of the two rivers; and the fortified zone, SSS, is the ring of forts lying far out all round Namur; while the passages, PP, over the obstacles contained within that fortified zone, and accessible to the people *inside* the angle from M, but not to the people *outside* the angle from NNN, are the bridges across both the Sambre and the Meuse at Namur.

All this is, of course, put merely diagrammatically, and a diagram is something very distant from reality. The "open

strategic square” in practice comes to mean little more than two main elements—one the operative corner, the other a number of separate units disposed in all sorts of different places behind, and gen-

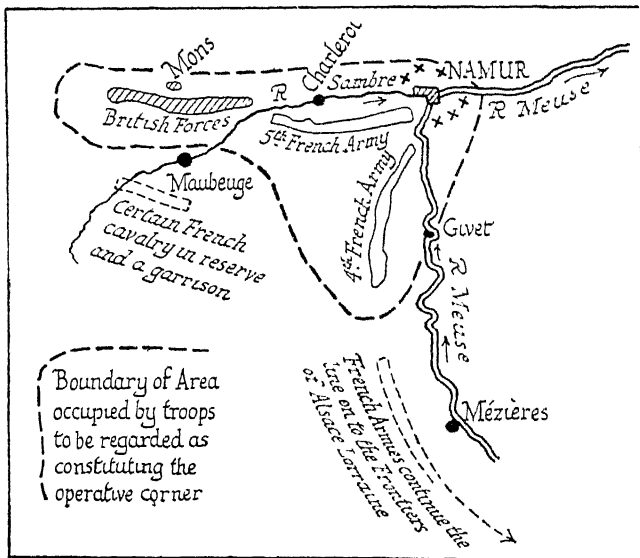

Sketch 39.

erally denominated “the manœuvring mass.” If you had looked down from above at all the French armies towards the end of August, when the first great shock came, you would have seen nothing remotely resembling a square.

You would have seen something like Sketch 31 where the bodies enclosed under the title A were the operative corner; various garrisons and armies in the field, enclosed under the title B, were the manœuvring mass. But it is only by putting the matter quite clearly in the abstract diagrammatic form that its principle can be grasped.

With this digression I will return and conclude with the main points of debate in the use of the open strategic square.

We have seen that the operative corner is in this scheme deliberately imperilled at the outset.

The following is a sketch map of the actual position, and it will be seen that the topographical features of this countryside are fairly represented by Sketch 39; while this other sketch shows how these troops that were about to take the shock stood to the general mass of the armies.

But to return to the diagram (which I repeat and amplify as Sketch 41), let us see how the Allied force in the operative corner before Namur stood with relation to this angle of natural obstacles, the two

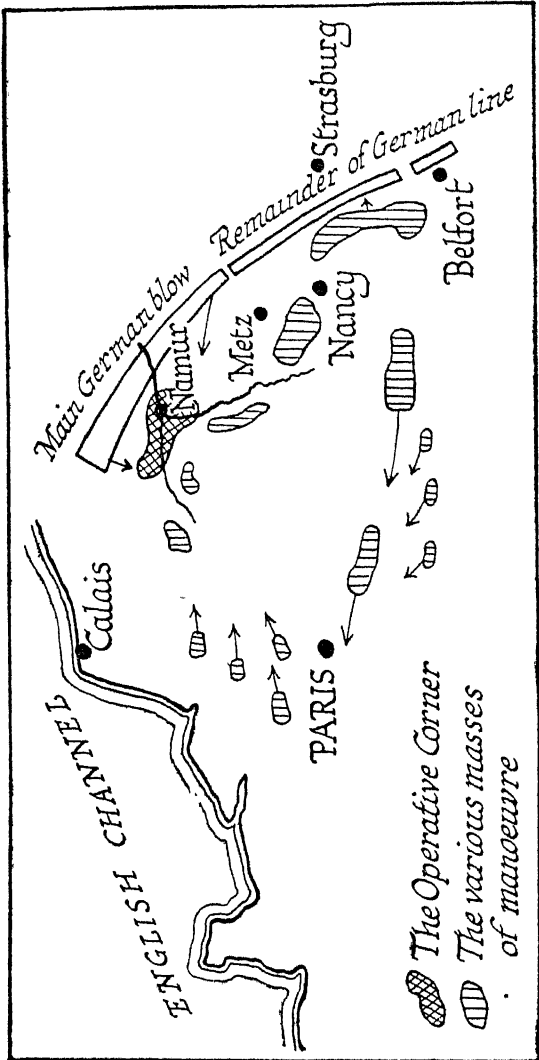

Sketch 40.

rivers Sambre and Meuse, and the fortified zone round the point where they met.

The situation of that force was as follows :—

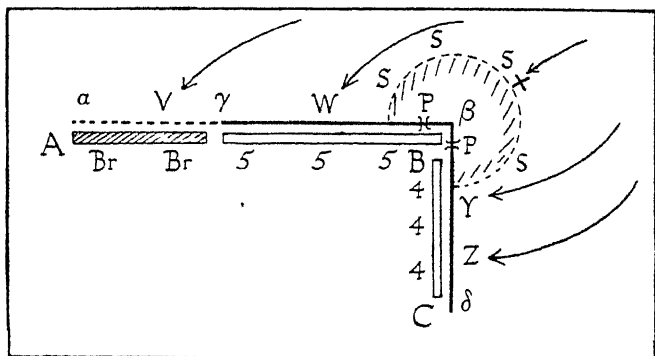

Sketch 41.

Along and behind $\beta\gamma$ stretched the 5th Army of the French, prolonged on its left by the British contingent. I have marked the first in the diagram with the figure 5, the second with the letters Br, and the latter portion I have also shaded. At right angles to the French 5th Army stretched the French 4th Army, which I have marked with the figure 4. It depended upon the obstacle of the Meuse $\beta\delta$ for its defence, just as the French 5th Army depended upon the Sambre, $\gamma\beta$. It must, of course, be understood

that when one says these forces "lay along" the aforesaid lines, one does not mean that they merely lay behind them. One means that they held the bridges and prepared to dispute the crossing of them.

Now, the French plan was as follows. They said to themselves: "There will come against us an enemy acting along the arrows VWXYZ, and this enemy will certainly be in superior force to our own. He will perhaps be as much as fifty per cent. stronger than we are. But he will suffer under these disadvantages:—

"The one part of his forces, V and W, will find it difficult to act in co-operation with the other part of his forces, Y and Z, because Y and Z (acting as they are on an outside circumference split by the fortified zone SSS) will be separated, or only able to connect in a long and round-about way. The two lots, V and W, and Y and Z, could only join hands by stretching round an awkward angle—that is, by stretching round the bulge which SSS makes, SSS being the ring of forts round Namur. Part of their forces (that along the arrow X) will further be used up in trying to break down the resistance of

SSS. That will take a good deal of time. If our horizontal line AB holds its own, naturally defended as it is, against the attack from V and W, while our perpendicular line BC holds its own still more firmly (relying on its much better natural obstacle) against YZ, we shall have ample time to break the first and worst shock of the enemy's attack, and to allow, once we have concentrated that attack upon ourselves, the rest of our forces, the masses of manœuvre, or at any rate a sufficient portion of them, to come up and give us a majority in *this* part of the field. We shall still be badly outnumbered on the line as a whole; but the resistance of our operative corner, relying on the Sambre and Meuse and the fortress of Namur, will gather much of the enemy unto itself. It will thus make of this part of the field the critical district of the whole campaign. Our masses, arriving while we resist, will give us a local superiority here which will hold up the whole German line. We may even by great good luck so break the shock of the attack as ourselves to begin taking the counter-offensive after a little while, and

to roll back either Y and Z or V and W by the advance of our forces across the rivers when the enemy has exhausted himself."

It will be clear that this calculation (whether of the expected and probable least favourable issue—a lengthy defence followed by an orderly and slow retreat designed to allow the rest of the armies to come up—or of the improbable and more favourable issue—the taking of the counter-offensive) depended upon two presumptions which the commander of the Allies had taken for granted: (1) that the German shock would not come in more than a certain admitted maximum, say thirty per cent. superiority at the most over the Allied forces at this particular point; (2) that the ring of forts round Namur would be able to hold out for at least three or four days, and thus absorb the efforts of part of the enemy as well as awkwardly divide his forces, while that enemy's attack was being delivered.

Both these presumptions were erroneous. The enemy, as we shall see in a moment, came on in much larger numbers than had been allowed for. Namur, as we have

already seen, fell, not in three or four days, but instantly—the moment it was attacked. And the result was that, instead of an orderly and slow retirement, sufficiently tardy to permit of the swinging up of the rest of the French “square”—that is, of the arrival of the other armies or manœuvring masses—there came as a fact the necessity for very rapid retirement of the operative corner over more than one hundred miles and the immediate peril for days of total disaster to it.

To appreciate how superior the enemy proved to be in number, and how heavy the miscalculation here was, we must first see what the numbers of this Allied operative corner were.

I have in Sketch 42 indicated the approximate positions and relative sizes of the three parts of the Allied forces.

Beginning from the left, we have barely two army corps actually present of the British contingent in the fighting line: for certain contingents of the outermost army corps had not yet arrived. We may perhaps call the numbers actually present at French's command when contact was taken 70,000 men, but that is probably beyond

the mark. To the east lay the 5th French Army, three army corps amounting, say, to 120,000 men, and immediately south of this along the Meuse lay the 4th French Army, another three army corps amounting to at the most another 120,000 men.

We may then call the whole of the operative corner (if we exclude certain cavalry reserves far back, which never came into play) just over 300,000 men. That there were as many as 310,000 is improbable.

The French calculation was that against these 300,000 men there would arrive at the very most 400,000.

That, of course, meant a heavy superiority in number for the enemy; but, as we have seen, the scheme allowed for such an inconvenience at the first contact.

That more than 400,000 could strike in the region of Namur no one believed, for no one believed that the enemy could provision and organize transport for more than that number.

A very eminent English critic had allowed for seven army corps of first-line men as all that could be brought across the Belgian

Plain. The French went so far as to allow for ten, a figure represented by the 400,000 men of the enemy they expected.

We had then the Allied forces expecting an attack in about the superiority indicated upon this diagram, where the British

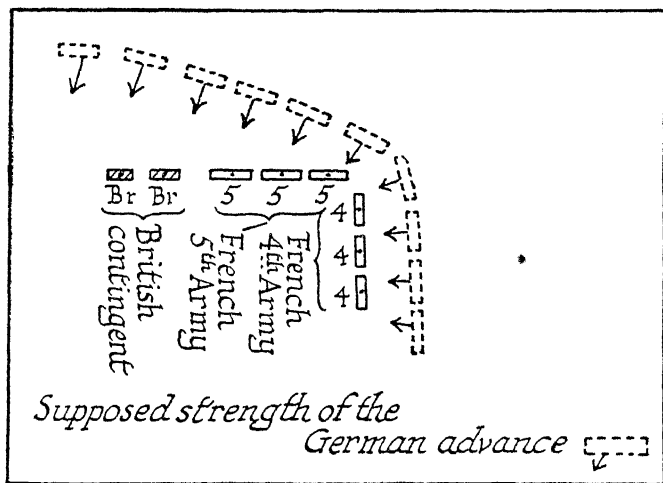

Sketch 42.

contingent and the two French armies are marked in full, and the supposed enemy in dotted lines.

Roughly speaking, the Allies were allowing for a thirty per cent. superiority.

Now, lying as they did behind the rivers, and with the ring of forts around Namur

to shield their point of junction and to split the enemy's attack, this superiority, though heavy, was not crushing. The hopes of the defensive that it would stand firm, or at least retire slowly so as to give time for the manœuvring masses to come up was, under this presumption, just. It was even thought possible that, if the enemy attacked too blindly and spent himself too much, the counter-offensive might be taken after the first two or three days.

As for the remainder of the German forces, it was believed that they were stretched out very much in even proportion, without any thin places, from the Meuse to Alsace.

Now, as a matter of fact, the German forces were in no such disposition. 1. The Germans had added to every army corps a reserve division. 2. They had brought through the Belgian plains a very much larger number than seven army corps: they had brought nine. 3. They had further brought against Namur yet another four army corps through the Ardennes, the woods of which helped to hide their progress from air reconnais-

sance. To all this mass of thirteen army corps, each army corps half as large again as the active or first line allowed for, add some imperfectly trained but certainly large bodies of independent cavalry. We cannot accurately say what the total numbers of this vast body were, but we can be perfectly certain that more than 700,000 men were massed in this region of Namur. The enemy was coming on, not four against three, but certainly seven against three, and perhaps eight or even nine against three.

The real situation was that given in the accompanying diagram (Sketch 43).

Five corps, each with its extra division, were massed under von Kluck, and called the 1st German Army. Four more, including the Guards, were present with von Buelow, and stretched up to and against the first defences of Namur. Now, around the corner of that fortress, two Saxon corps, a Wurtemberg corps, a Magdeburg corps, and a corps of reserve under the Duke of Wurtemberg formed the 3rd Army, the right wing of which opposed the forts of Namur, the rest of which stretched along the line of the Meuse.

Even if the forts of Namur had held out, the position of so hopelessly inferior a body as was the Franco-British force, in face of such overwhelming numbers, would have been perilous in the extreme. With the forts of Namur abandoned almost at the first blow, the peril was more than a

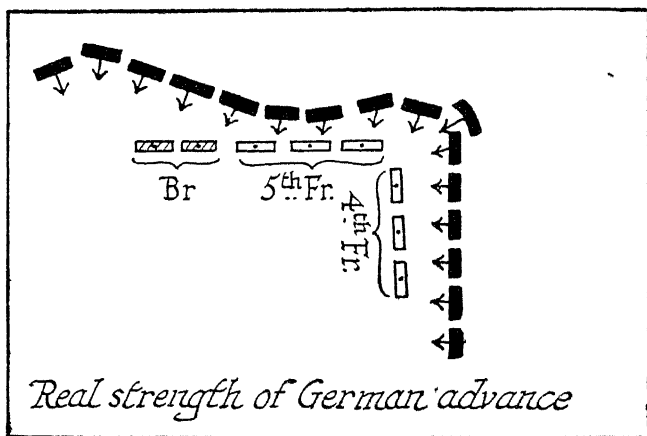

Sketch 43.

peril. It had become almost certain disaster.

With the fall of Namur, the angle between the rivers—that is, the crossings of the rivers at their most difficult part where they were broadest—was in the hands of the enemy, and the whole

French body, the 4th and 5th Armies, was at some time on that Saturday falling back.

The exact hour and the details of that movement we do not yet know. We do not know what loss the French sustained, we do not know whether any considerable bodies were cut off. We do not know even at what hour the French General Staff decided that the position was no longer tenable, and ordered the general retreat.

All we know is that, so far from being able to hold out two or three days against a numerical superiority of a third and under the buttress of Namur, the operative corner, with Namur fallen and, not 30 per cent., but something more like 130 per cent. superiority against it, began not the slow retreat that had been envisaged, but a retirement of the most rapid sort.

Such a retirement was essential if the cohesion of the Allied forces was to be maintained at all, and if the combined 4th and 5th French Armies and British contingent were to escape being surrounded or pierced.

By the Saturday night at latest the French retirement was ordered ; by Sunday morning it was in full progress, and it was proceeding throughout the triangle of the Thierarche all that day.

But the rate of that retirement, corresponding to the pressure upon the French front, differed very much with varying sections of the line. It was heaviest, of course, in those advanced bodies which had lain just under Namur. It was least at the two ends of the bow, for the general movement was on to the line Maubeuge-Mezières. The farther one went east towards Maubeuge, the slower was the necessary movement, and to this cause of delay must be added the fact that von Kluck, coming round by the extreme German line, had farthest to go, and arrived latest against the line of the Allies.

Therefore the British contingent at the western extreme of the Allied line felt the shock latest of all, and all that Sunday morning the British were still occupied in taking up their positions. They had arrived but just in time for what was to follow.

It was not till the early afternoon of

the Sunday that contact was first taken seriously between Sir John French and von Kluck. At that moment the British commander believed, both from a general and erroneous judgment which the French command had tendered him and from his own air work, that he had in front of him one and a half or at the most two army corps; and though the force, as we shall see in a moment, was far larger, its magnitude did not appear as the afternoon wore on. Full contact was established perhaps between three and four, by which hour the pressure was beginning to be severely felt, and upon the extreme right of the line it had already been necessary to take up defensive positions a little behind those established in the morning. But by five o'clock, with more than two good hours of daylight before it, the British command, though perhaps already doubtful whether the advancing masses of the enemy did not stand for more men, and especially for more guns than had been expected, was well holding its own, when all its dispositions were abruptly changed by an unexpected piece of news.

It was at this moment in the afternoon—that is, about five o'clock—that the French General Staff communicated to Sir John French information bearing two widely different characteristics: the first that it came late; the second that had it not come when it did, the whole army, French as well as British, would have been turned.

The first piece of information, far too belated, was the news that Namur had fallen, and that the enemy had been in possession of the bridge-heads over the Sambre and the Meuse since the preceding day, Saturday. Consequent upon this, the enemy had been able to effect the passage of the Sambre, not only in Namur itself, but in its immediate neighbourhood, and, such passages once secured, it was but a question of time for the whole line to fall into the enemy's hands. When superior numbers have passed one end of an obstacle it is obvious that the rest of the obstacle gradually becomes useless.* At what hour

* AA is holding the obstacle OO against a superior number BB. There are six passages across OO. If BB forces No. 5 and No. 6 he creates the situation in the following diagram, where it is obvious that BB is

the French knew that they had to retire, we have not been told. As we have seen, the enemy was right within Namur on the early afternoon of Saturday, the 22nd, and it is to be presumed that the French retirement was in full swing by the Sunday morning, in which case the British contingent, which this retirement left in peril upon the western extreme of the line, ought to have been warned many hours before five o'clock in the afternoon.

To what the delay was due we are again

now on the flank of AA, and that AA must retire, even if he still holds passages 1, 2, 3, and 4. That is what happened when Namur fell. The French could hold, and were holding, the Germans along the Sambre, above Namur; but the bridges of Namur, which were thought safe behind the forts, had fallen into German hands.

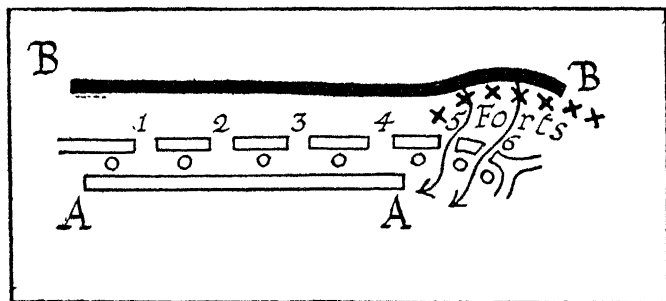

Sketch 44.

as yet in ignorance, but probably to the confusion into which the unexpected fall of Namur and the equally unexpected strength of the enemy beyond the Sambre and the Meuse had thrown the French General Staff.

At any rate, the news did come thus late, and its lateness was of serious consequence to the British contingent, and might have been disastrous to it.

The second piece of news, on the other hand, was the saving of it; and that second piece of news was the information that Sir John French had in front of him not one German army corps, and possibly part or even the whole of a second, but at least three. As the matter turned out, the British contingent was really dealing first and last with four army corps, and the essential part of the news conveyed was that the extreme western portion of this large German force *was attempting to turn the flank of the whole army.*

It was not only attempting to do so, it was in number sufficient to do so; and unless prompt measures were taken, what was now discovered to be the general German plan would succeed, and the cam-

campaign in the West would be in two days decided adversely to the Allies—the same space of time in which the campaign of 1815 was decided adversely to Napoleon in just these same country-sides.

It is here necessary to describe what this German plan was.

The reader has already seen, when the general principles of the open strategic square were described on a previous page, that everything depends upon the fate of the operative corner. This operative corner in the present campaign had turned out to be the two French armies, the 4th and the 5th, upon the Lower Sambre and the Meuse, and the British contingent lying to the left of the 5th on the Upper Sambre and by Mons.

If the operative corner of a strategic open square is annihilated as a military force, or so seriously defeated that it can offer no effective opposition for some days, then the whole plan of a strategic square breaks to pieces, and the last position of the inferior forces which have adopted it is worse than if they had not relied upon the manœuvre at all, but had simply spread out in line to await defeat

in bulk at the hands of their superior enemy.

Now there are two ways in which a military force can be disposed of by its opponent. There are two ways in which it can be—to use the rather exaggerated language of military history—“annihilated.”

The first is this: You can break up its cohesion by a smashing blow delivered somewhere along its line, and preferably near its centre. But if you do that, the results will never be quite complete, and may be incomplete in any degree according to the violence and success of your blow.

The second way is to get round the enemy with your superior numbers, to get past his flank, to the back of him, and so envelop him. If that manœuvre is carried out successfully, you bag his forces entire. It is to this second manœuvre that modern Prussian strategy and tactics are particularly attached. It is obvious that its fruits are far more complete than those of the first manœuvre, when, or if, it is wholly successful. For to get round your enemy and bag him whole is a larger result than merely to break him up and leave *some* of him able to re-form and perhaps fight

again. Two things needful to such success are (a) superior numbers, save in case of gross error upon the part of the opponents; (b) great rapidity of action on the part of the outflanking body, coupled, if possible, with surprise. That rapidity of action is necessary is obvious; for the party on the flank has got to go much farther than the

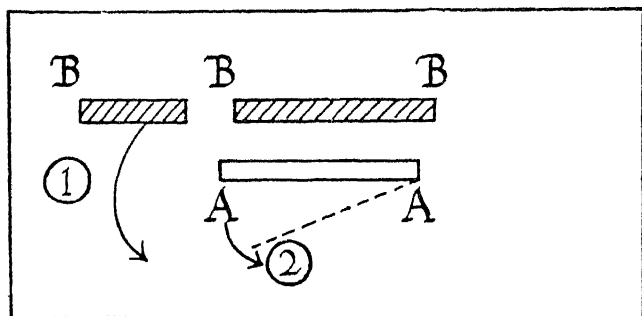

Sketch 45.

rest of the army. It has to go all the length of the arrow (1), and an element of surprise is usually necessary. For if the army AA which BB was trying to outflank learned of the manœuvre in time he only has to retreat upon his left by the shorter arrow (2) to escape from the threatened clutch.

Now, von Kluck with his five army corps, four of which were in operation

against Sir John French, was well able to count on all these elements. He had highly superior numbers, his superiority had not been discovered until it was almost too late, and for rapidity of action he had excellent railways and a vast equipment of petrol vehicles.

What he proposed to do was, while engaging the British contingent of less than two army corps with three full army corps of his own, to swing his extreme western army corps right round, west through Tournai, and so turn the British line. If he succeeded in doing that, he had at the same time succeeded in turning the whole of the Franco-British forces on the Sambre and Meuse. In other words, he was in a fair way to accomplishing the destruction of the operative corner of the great square, and consequently, as a last result, the destruction of the whole Allied force in the West.

The thing may be represented on a sketch map in this form.

Of von Kluck's five corps, 1 is operating against the junction of the English and French lines beyond Binche, 2, 3, and 4 are massing against the rather more than one

and a half of Sir John French at AA, and 5, after the capture of Tournai, is going to take a big sweep round in the direction of the arrow towards Cambrai, and so to turn the whole line. Meanwhile, the cavalry, still farther west, acting independently, is to sweep the country right out to Arras and beyond.

The particular titles of corps are of no

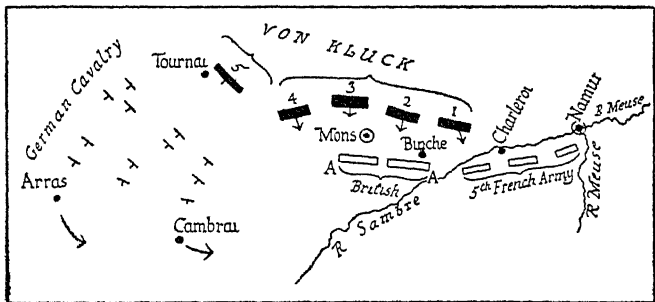

Sketch 46.

great value in following the leading main lines of a military movement; but it may be worth remembering that this "number 5," to which von Kluck had allotted the turning movement, was the *Second* German Corps. With its cavalry it numbered alone (and apart from all the other forces of von Kluck which were engaging the British line directly) quite three-quarters as many

men as all that British line for the moment mustered.

It was not possible, from local circumstances which the full history of the war, when it is written, will explain, for the British contingent to fall back in the remaining hours of daylight upon that Sunday.

Belated by at the most twelve hours, as the news of the French retirement had been, the British retirement followed it fully twenty hours after. It was not until daylight of Monday, the 24th, that all the organizations for this retirement were completed, the plans drawn up, and the first retrograde movements made.

To permit a retirement before such a great superiority of the enemy to be made without disaster, it was necessary to counter-attack not only at this inception of the movement, but throughout all the terrible strain of the ensuing eight days.

Here it may be necessary to explain why, in any retirement, continual counter-attacks on the pursuing enemy are necessary.

It is obvious that, under equal condi-

tions, the pursuing enemy can advance as fast as can your own troops which are retreating before him. If, therefore, a retreat, once contact has been established, consisted in merely walking away from the enemy, that enemy would be able to maintain a ceaseless activity against one portion of your united force—its rear—which activity would be exercised against bodies on the march, and incapable of defence. To take but one example out of a hundred: his guns would be always unlimbering, shooting at you, then limbering up again to continue the pursuit; unlimbering again, shooting again—and so forth; while your guns would never reply, being occupied in an unbroken retirement, and therefore continually limbered up and useless behind their teams.

A retiring force, therefore, of whatever size—from a company to an army—can only safely effect its retirement by detaching one fraction from its total which shall hold up the pursuit for a time while the main body gets away.

When this detached fraction is wearied or imperilled, another fraction relieves

it, taking up the same task in its turn ; the first fraction, which had hitherto been checking the pursuit, falls back rapidly on to the main body, under cover of the new rearguard's fire as it turns to face the enemy. And the process is kept up, first one, then another portion of the whole force being devoted to it, until the retirement of the whole body has been

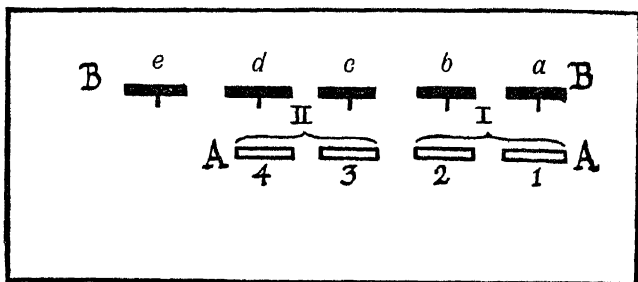

Sketch 47.

successfully effected, and it is well ahead of its pursuers and secure.

For example : two White army corps, I., II., as in the annexed diagram, each of two divisions, 1, 2, and 3, 4, have to retire before a greatly superior Black force, *abcde*. They succeed in retiring by the action expressed in the following diagram. White corps No. I. first undertakes to hold up the enemy while No. II. makes off.

No. I. detaches one division for the work (Division 2), and for a short time it checks the movement of *a*, *b*, and *c*, at least, of the enemy. Now *d* and *e* press on. But they cannot press on at any pace they choose, for an army must keep together, and the check to *a*, *b*, and *c*

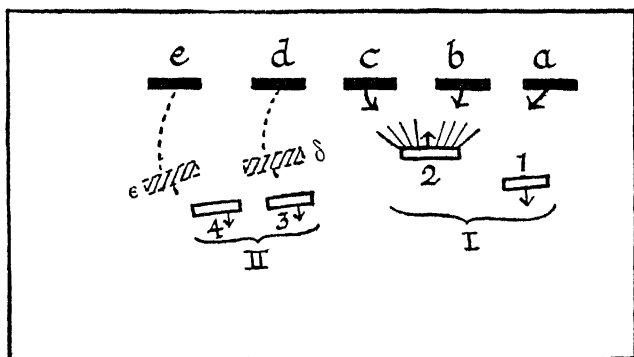

Sketch 48.

somewhat retards *d* and *e*. They advance, say, to the positions $\delta \epsilon$.

Next, White corps No. II. stops, puts out one of its divisions (say 4) to check *d* and *e*, while its other division either helps or falls back, according to the severity of the pressure, and White corps No. I. makes off as fast as it can. *a*, *b*, *c*, no longer checked by a White rearguard,

258 A GENERAL SKETCH OF

are nevertheless retarded from two causes—first, the delay already inflicted on them; secondly, that they must not, if the army is to keep together, get too far ahead of their colleagues, *d* and *e*, which White corps II. is holding up.

Thus, on the second or third day the

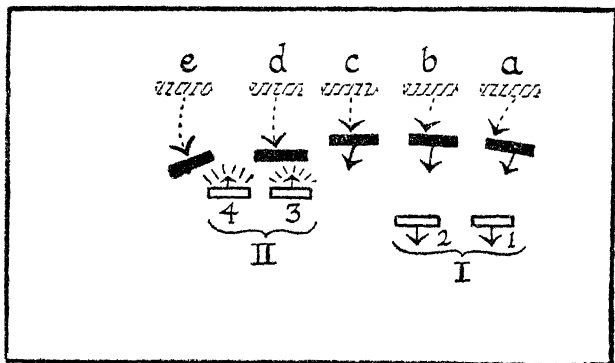

Sketch 49.

retreat of White is being secured by an increasing gap between pursued and pursuers. The process is continued. Every succeeding day—if that process is successful—should further widen the gap until White can feel free from immediate pressure.

Such is the principle—modified indefinitely in practice by variations of ground

and numbers—under which a retirement must be conducted if it is to have any hope of ultimate success in saving the pursued.

But it is clear that the process must always be a perilous one. Unless the most careful co-ordination is maintained between the moving parts of the retreat; unless the rearguard in each action falls back only *just upon* and not a *little while after* the precise moment when it can last safely do so; unless the new rearguard comes into play in time, etc., etc.—the pursuers may get right in among the pursued and break their cohesion; or they may get round them, cut them off, and compel them to surrender. In either case the retreating force ceases to exist as an army.

In proportion as the pursuers are numerous (mobility being equal) compared with the pursued, in that proportion is the peril. And with the best luck in the world some units are sure to be cut off, many guns lost, all stragglers and nearly all wounded abandoned in the course of a pressed retreat, and, above all, there will be the increasing discour-

agement and bewilderment of the men as the strain, the losses, and the ceaseless giving way before the enemy continue day after day with cumulative effect.

The accomplishment of such a task, the maintenance of the "operative corner" in being during its ordeal of retreat before vastly superior numbers, and in particular the exceedingly perilous retirement of the British contingent at what was, during the first part of the strain, the extreme of the line, are what we are now about to follow.

The initial counter-attack, then, on this Monday, the first day of the retreat, was undertaken by the 2nd British Division from the region of Harmignies, which advanced as though with the object of retaking Binche. The demonstration was supported by all the artillery of the 1st Army Corps, while the 1st Division, lying near Peissant, supported this action of the 2nd. While that demonstration was in full activity, the 2nd Corps to the west or left (not all of it was yet in the field) retired on to the line Dour-Frameries, passing through Quaregnon. It suffered some loss in this operation from the

masses of the enemy, which were pressing forward from Mons. When the 2nd Corps had thus halted on the line Dour-Frameries, the 1st Corps, which had been making the demonstration, took the opportunity to retire in its turn, and fell

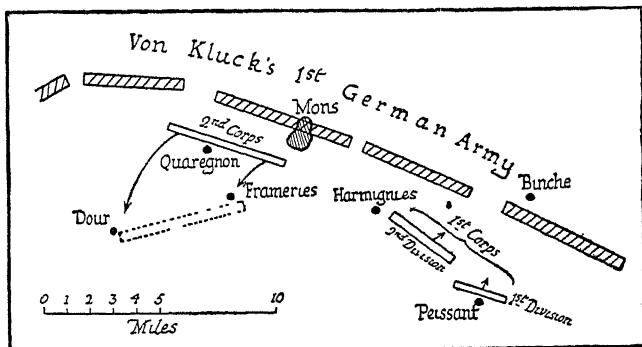

Sketch 50.

back before the evening to a line stretching from Bavai to Maubeuge.

The 2nd Corps had entrenched itself, while the 1st Corps was thus falling back upon its right; and when it came to the turn of the 2nd Corps to play the part of rearguard in these alternate movements, the effort proved to be one of grave peril.

Since the whole movement of the enemy was an outflanking movement, the pres-

sure upon this left and extreme end of the line was particularly severe. The German advance in such highly superior numbers overlapped the two British corps to *their* left or west, which was at this moment the extreme end of the Allied Franco-British line. They overlapped them as these pursuing Black units overlap the lesser retiring White units. It is

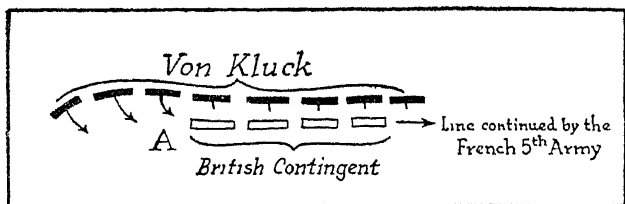

Sketch 51.

evident that in such a case the last unit in the line at A will be suffering the chief burden of the attack. An attempt was made to relieve that burden by sending the 2nd Cavalry Brigade in this direction to ride round the enemy's outlying body; but the move failed, with considerable loss to the 9th Lancers and the 18th Hussars, which came upon wire entanglements five hundred yards from the enemy's position. There did arrive in aid of the imperilled end of the line

reinforcement in the shape of a new body. One infantry brigade, the 19th, which had hitherto been upon the line of communications, reached the army on this its central left near Quarouble and a little behind that village before the morning was spent. It was in line before evening. This reinforcement lent some strength to the sorely tried 2nd Corps, but it had against it still double its own strength in front, and half as much again upon its exposed left or western flank, and it suffered heavily.

By the night of that Monday, the 24th of August, however, the whole of the British Army was again in line, and stretched from Maubeuge, which protected its right, through Bavai, on to the fields between the villages of Jenlain and Bry, where the fresh 19th Infantry Brigade had newly arrived before the evening, while beyond this extreme left again was the cavalry.

The whole operation, then, of that perilous Monday, the first day of the retreat, may be planned in general as in Sketch 52. At the beginning, at day-break, you have the three German army

corps lying as the shaded bodies are given opposite to the unshaded, which represent the British contingent of not quite two full army corps. By night-fall the British contingent, including now the 19th Brigade of infantry, lay in the positions from Maubeuge westward, with the 1st Corps next to Maubeuge, the 2nd Corps beyond Bavai, the 1st being commanded by Sir Douglas Haig, the 2nd by Sir Horace Smith-Dorrien; while the Germans lay more or less as the dotted shaded markings are.

The fortress of Maubeuge was, under these circumstances, clearly a lure. An army in the field in danger of envelopment will always be tempted to make for the nearest fortified zone in order to save itself. The British commander was well advised in his judgment to avoid this opportunity, and that for two reasons. First, that the locking up of any considerable portion of the Anglo-French force in its retirement would have jeopardized the chance of that counter-offensive which the French hoped sooner or later to initiate; secondly, that, as will be seen later, the works of Maubeuge were quite insufficient

to resist for more than a few days a modern siege train.

This point of Maubeuge and of its fall must be discussed later ; for the moment all we need note is that the fortress afforded

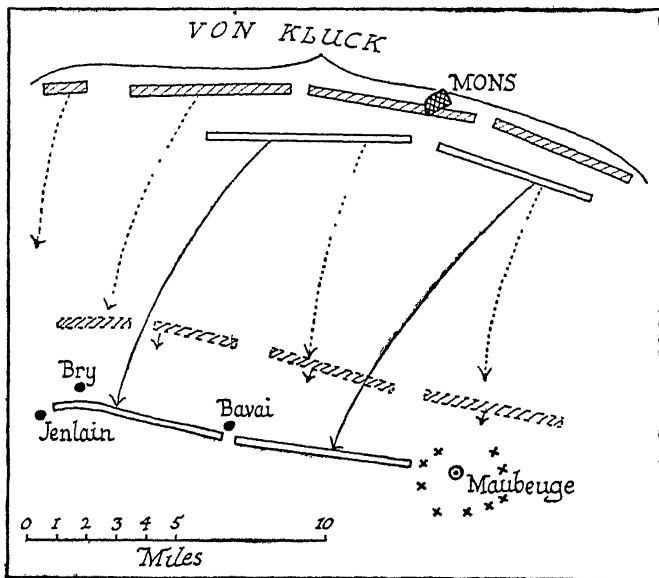

Sketch 52.

for a few hours—that is, during the night of Monday to Tuesday, the 24th–25th August—support to the British line during its first halt upon the rapid and perilous retirement from Mons.

Meanwhile the whole of the French 5th

Army had been falling back with equal rapidity, and upon its right the 4th Army had followed soon ; and as this French retirement had preceded the retirement of the British, its general line lay farther south.

On the other hand, from the nature of the topography in this section of the Franco-Belgian border, the units of the French command had to fall back farther and more rapidly in proportion as they stretched eastward. The attack of the enemy in forces of rather more than two to one had come, as we have seen, not only from across the line of the Sambre, but, once Namur had fallen, from across the line of the Meuse at right angles to the line of the Sambre. Therefore the 5th and the 4th Armies, contained within the triangle bounded by the Sambre and Meuse, retiring from blows struck from the direction of the arrows 1-5 over all that hilly and wooded country known as the Thiérache, were, as to the extreme salient of them at A, compelled to a very rapid retirement indeed ; and on this Sunday night the French line was deflected southward, not without heavy losses, until either on that

night or on the Monday morning it joined up with the forces which stretched northward through and from Mézières. An attempt to counter-attack through the precipitous ravines and deep woods on to the valley of the Semois had failed, and the line as a whole ran, upon this night be-

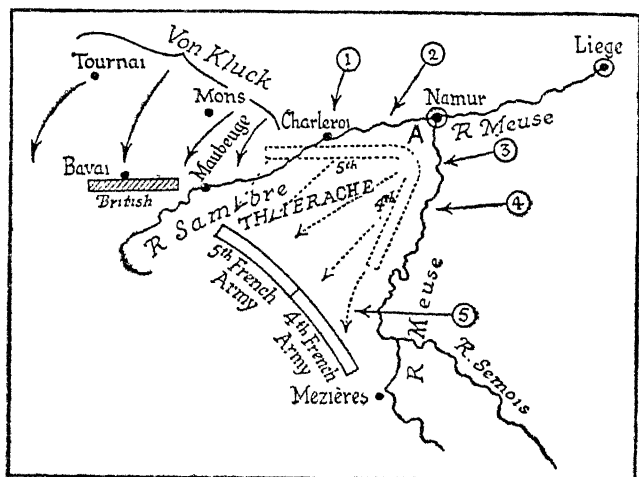

Sketch 53.

tween the Sunday and the Monday, much as is indicated upon the accompanying sketch.

From this it will be seen that the British contingent away upon the extreme left was in very grave peril, not only because the turning movement was wholly

directed round their exposed flank, but also because, their retirement having come late, they stood too far forward in the general scheme at this moment, and therefore more exposed to the enemy's blow than the rest of the line. With this it must be remembered Tournai had already fallen. It was very imperfectly held by a French Territorial brigade, accompanied by one battery of English guns; and the entering German force, in a superiority of anything you like—two, three, or four to one—easily swept away the resistance proffered in this quarter.

These German forces from Tournai had not yet, by the nightfall of Monday, come up eastward against the British, but they were on the way, and they might appear at any moment. The corps next to them, the 4th of von Kluck's five, was already operating upon that flank, and the next day, Wednesday, 26th of August, was to be the chief day of trial for this exposed British wing of the army.

So far the operations of the British Army had not differed greatly from the expected or at least one of the expected developments of the campaign.

The operative corner, if it should not have the luck, through losses or blunders on the part of the enemy, to take the counter-offensive after receiving the third shock, is intended to retire, and to draw upon itself a maximum of the enemy's efforts.

But between what had been intended as the most probable, and in any case perilous, task of this body (which comprised, it will be remembered, six French and ultimately two British army corps) turned out, within twenty-four hours of the retreat, and within forty-eight of the fall of Namur, to be an operation of a difficulty so extreme as to imperil the whole campaign, and in this operation it was the British force upon the outer left edge of the line—the unsupported extremity round which the enemy made every effort to get—which was bound to receive the severest treatment. This peculiar burden laid upon the Expeditionary Force from this country was, of course, gravely increased by the delay in beginning its retreat, which we have seen to be due to the delay in the communication to it by the French of the news of the fall of Namur. On account of

this delay not only was the extreme of the line which the British held immediately threatened with outflanking, but it still lay somewhat forward of the rest of the force. It was in danger of being turned round its exposed edge C, not only because it lay on the extreme of the line, but also because, instead of occupying its normal position,

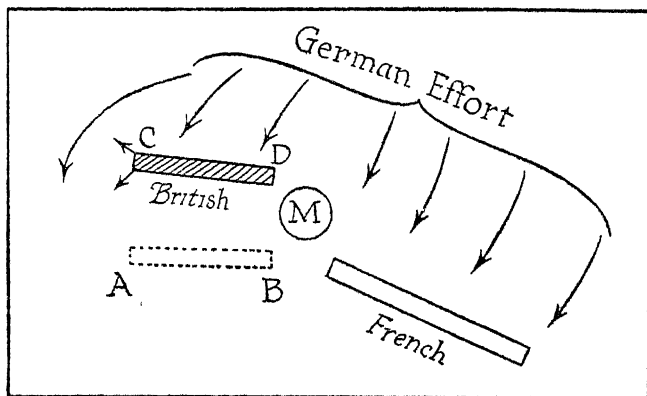

Sketch 54.

AB, which it would have occupied had the retreat begun with all the rest, it actually occupied the position CD, which made it far more likely to be surrounded than if it had been a day's march farther back, as it would have been if the French Staff work had suffered no delays.

There lay in the gap formed by this

untoward tardiness in the British retirement, at the point M, the fortress of Maubeuge. It was garrisoned by French reserves, or Territorial troops, not of the same quality as the active army, and its defensive power was, even if the old ring of fortress theory had proved sound, of very doubtful order.

The French 5th Army being no longer present to support the British right, but having fallen back behind the alignment of that right, General Sir John French had no support for what should have been his secure flank save this fortress of Maubeuge, and it will be evident from the above diagram that the enemy, should he succeed in outflanking the British line, would compel it to fall back within the ring of forts surrounding Maubeuge. To avoid destruction it would have no alternative but to do that. For, counting the forces in front of it and the forces trying to get round its back, it was fighting odds of two to one.

Maubeuge was a stronghold that had played a great part in the revolutionary war. Its resistance in the month of October 1793 had made possible the French vic-

tory of Wattignes, just outside its walls, and had, perhaps, done more than any other feat of arms in that year to save the French Revolution from the allied governments of Europe. It was, indeed, full of historic memories, from the moment when Cæsar had defeated the Nervii upon the Sambre just to the west of the town (his camp can still be traced in an open field above the river bank) to the invasion of 1815.

But this rôle which it had played throughout French history had not led to any illusion with regard to the rôle it might play in any modern war; and at the best Maubeuge, in common with the other ill-fortified points of the Belgian frontier, suffered from the only error—and that a grave one—which their thorough un-national political system had imposed upon the military plan of the French. This error was the capital error of indecision. No consistent plan had been adopted with regard to the fortification of the Belgian frontier.

The French had begun, after the recuperation following upon the war of 1870, an elaborate and very perfect sys-

tem of fortification along their German frontier—that is, along the new frontier which divided the annexed territory of Alsace-Lorraine from the rest of the country. They had taken it for granted that the next German attempt would be made somewhere between Longwy and Belfort. And they had spent in this scheme of fortification, first and last, the cost of a great campaign. They had spent some three hundred million pounds; and it will be possible for the reader to gauge the magnitude of this effort if he will consider that it was a military operation more costly than was the whole of the South African War to Great Britain, or of the Manchurian War to Russia. The French were wise to have undertaken this expense, because it had hitherto been an unheard-of offence against European morals that one nation in Christendom should violate the declared neutrality of another. And the attack upon Belgium as a means of invading France by Germany had not then crossed the mind of any but a few theorists who had, so to speak, “marched ahead” of the rapid decline in our common religion

which had marked now three generations.

But when the French had completed this scheme of fortification, Europe heard it proposed by certain authorities in Prussia that, as the cost of invading France through the now fortified zone would be considerable, the German forces should not hesitate to originate yet another step in the breakdown of European morality, and to sacrifice in their attack upon France the neutrality of Belgium, of which Prussia was herself a guarantor.

Men have often talked during this war, especially in England, as though the crime accompanying Prussian activities in the field were normal to warfare; and this error is probably due to the fact that war upon a large scale has never come home to the imagination of the country, and that it is without experience of invasion.

Yet it is of the very first importance to appreciate the truth that Prussia in this campaign has postulated in one point after another new doctrines which repudiate everything her neighbours have held sacred from the time when a common Christianity first began to influence the states

of Europe. The violation of the Belgian territory is on a par with the murder of civilians in cold blood, and after admission of their innocence, with the massacre of priests, and the sinking without warning of unarmed ships with their passengers and crews. To regard these things as something normal to warfare in the past is as monstrous an historical error as it would be to regard the reign of terror during the French Revolution as normal to civil disputes within the State. And to appreciate such a truth is, I repeat, of especial moment to the understanding of the mere military character of the campaign. For if the violation of Belgium in particular had not been the unheard of thing it was, the fortification of the Franco-Belgian frontier with which we are here concerned would have had a very different fortune.

As it was, the French could never quite make up their minds—or rather the French parliamentarians could never make up their minds—upon the amount of money that might wisely be expended in the defence of this neutral border. There were moments when the opinion that Prussia

would be restrained by no fear of Europe prevailed among the professional politicians of Paris. The fortification of the Belgian frontier was undertaken in such moments ; a full plan of it was drawn up. But again doubt would succeed, the very large sums involved would appal some new ministry, and the effort would be interrupted. To such uncertainty of aim characteristic of parliamentary government in a military nation was added, unfortunately, the consideration of the line of the Meuse. Liége and Namur were fortresses of peculiar strength, Antwerp was thought the strongest thing in Europe ; and that triangle was conceived, even by many who believed that the violation of Belgian territory would take place, as affording a sufficient barrier against the immediate invasion of France from the north-east. Those who made this calculation did not forget that fortresses are nothing without their full complement of men, guns, and stores ; but they could neither control, nor had they the elements properly to appreciate, the deficiency of organization in a foreign and not military country.

For all these causes Maubeuge, in common with other points along the Belgian frontier less important than itself, was left imperfect. Even if the ring fortress had remained after 1905 what it had been before that date, and even if modern howitzer fire and modern high explosives had not rendered its tenure one of days rather than months, Maubeuge was not a first-class fortress. As it was, with fortifications unrenewed, and with the ring fortress in any case doomed, Maubeuge was a death-trap.

The rôle assigned to the fortress in the original French plan was no more than the support of the retiring operative corner, as it "retreated, manœuvred, and held the enemy." Maubeuge was considered as part of a line beyond which the operative corner would not have to fall before the rest of the square, the "manœuvring mass," had swung up. Hence it was that the French General Staff and its Chief had put within the ring of its insufficient forts nothing more than a garrison of Territorials—that is, of the older classes of the reserve.

Had the British General accepted the

lure of Maubeuge as Bazaine did the lure of Metz in 1870, the Expeditionary Force would have been destroyed. But it would have been destroyed, not after a long delay, as was the army at Metz, but immediately; for Maubeuge was not Metz, and the fortress power of resistance of to-day is not that of a generation ago. Maubeuge, as a fact, fell within a fortnight of the date when this temptation was offered to the sorely pressed British army, and had that temptation been yielded to, the whole force would have been, in a military sense, annihilated before the middle of September.

What preserved it was the immediate decision undertaken upon that Monday night to proceed, in spite of the fatigues that were already felt after the first day's retreat, with a retirement upon the south-west, and to proceed with it as vigorously as possible.

It was not yet daylight upon the morning of Tuesday, August 25th, when the move began. The Field-Marshal counted justly upon some exhaustion in his immensely superior enemy, especially in those troops of his upon the west (the

2nd German Corps) which had to perform the heavy marching task of getting round the end of the British line. This element, combined with the considerable distance which the British marched that morning, saved the army; though not until another week of almost intolerable suffering had passed, and not until very heavy losses indeed had been sustained. The great Maubeuge-Bavai road, which is prolonged to Eth, and which was, roughly, the British front of that night, was cleared shortly after sunrise. A couple of brigades of cavalry and the divisional cavalry of the 2nd Corps covered the operation on the centre of the right, in front of the main body of the 2nd Corps, while the rest of the cavalry similarly covered the exposed western edge and corner of the line.

Delays, with the criticism of which this short summary has no concern, had forbidden the whole force which should have been present with the British Army in Flanders at the outset of the campaign to arrive in time, and the contingents that had already come up had taken the shock, as we have already described, in the absence of the 4th Divi-

sion. This 4th Division had only begun to detrain from the junction at Le Cateau at the same hour that General Sir John French was reading that Sunday message which prompted his immediate retirement from before Mons. When the full official history of the war comes to be written, few things will prove of more credit to the Expeditionary Force and its command than the way in which this belated division—belated through no fault of the soldiers—was incorporated with the already existing organization, in the very midst of its retreat, and helped to support the army. There are few parallels in history to the successful accomplishment of so delicate and perilous an operation.

At any rate, in less than forty-eight hours after its arrival, the 4th Division—eleven battalions and a brigade of artillery—were incorporated with the British line just as the whole force was falling back upon this Tuesday morning, the 25th; and the newly arrived division of fresh men did singular service in the further covering of the retirement. General Snow, who was in command of this division,

was deployed upon a line running from just south of Solesmes, on the right, to a point just south of La Chatrie, upon the road from Cambrai to Le Cateau, upon his left; and, as will be seen by the accompanying sketch map, such a line effectually protected the falling back of the rest of the force. Behind it the 1st

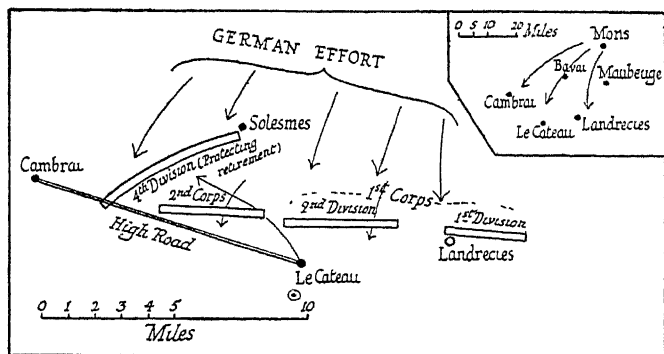

Sketch 55.

and the 2nd British Corps fell back upon the line Cambrai to Landrecies. The small inset map shows how the various points in this two days' retreat stood to one another.

This line from Landrecies towards Cambrai had already been in part prepared in the course of that day—Tuesday—and entrenched, and it may

be imagined what inclination affected commanders and men towards a halt upon that position. The pressure had been continuous and heavy, the work of detraining and setting in line the newly arrived division had added to the anxieties of the day, and an occupation of the prepared line seemed to impose itself. Luckily, the unwisdom of such a stand in the retirement was perceived in time, and the British Commander decided not to give his forces rest until some considerable natural object superior to imperfect and hurriedly constructed trenches could be depended upon to check the enemy's advance. The threat of being outflanked was still very grave, and the few hours' halt which would have been involved in the alternative decision might, or rather would, have been fatal.

The consequences, however, to the men of this decision in favour of continual retirement were severe. The 1st Corps did not reach Landrecies till ten o'clock at night. They had been upon the move for eighteen hours; but even so, the enemy, in that avalanche of advance (which was possible to him, as we now

know, by the organization of mechanical transport), was well in touch. The Guards in Landrecies itself (the 4th Brigade) were attacked by the advance body of the 9th German Army Corps, which came on in overwhelming numbers right into the buildings of the town, debouching from the wood to the north under cover of the darkness. Their effort was unsuccessful. They did not succeed in piercing or even in decisively confusing the British line at this point; and, packed in the rather narrow street of Landrecies, the enemy suffered losses equivalent to a battalion in that desperate night fighting. But though the enemy here failed to achieve his purpose, his action compelled the continued retreat of men who were almost at the limit of exhaustion, and who had now been marching and fighting for the better part of twenty-four hours.

In that same darkness the 1st Division, under Sir Douglas Haig, was heavily engaged south-east of Maroilles. They obtained ultimately the aid of two French reserve divisions which lay upon the right of the British line, and extricated them-

selves from the peril they were in before dawn. By daylight this 1st Corps was still continuing its retirement in the direction of Wassigny, with Guise as its objective.

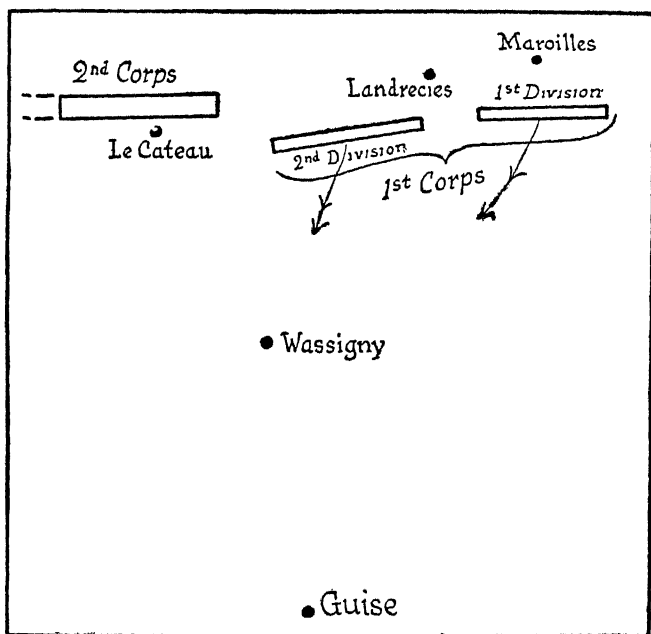

Sketch 56.

Meanwhile the 2nd Corps, which had not been so heavily attacked, and which lay to the west—that is, still upon the extreme of the line—had come, before the sunset of that Tuesday, the 25th, into

a line stretching from Le Cateau to near Caudry, and thence prolonged by the 4th Division towards Seranvillers.

It will be seen that this line was bent—its left refused. This disposition was,

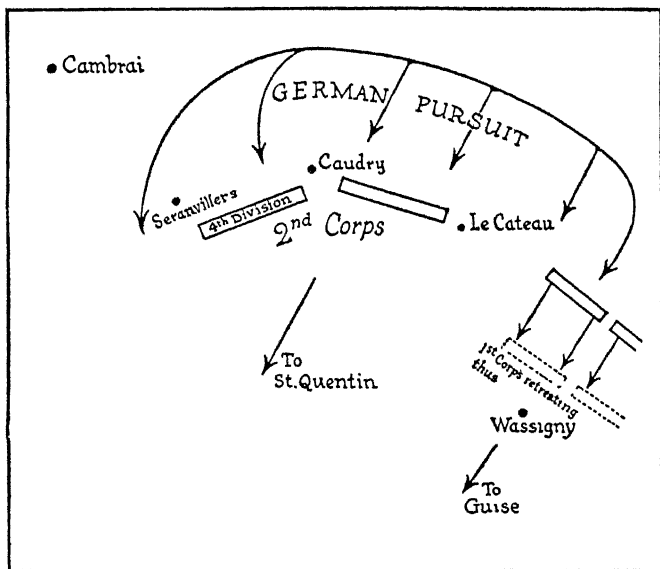

Sketch 57.

of course, designed to meet the ceaseless German attempt to outflank on the west; and with the dawn of Wednesday, the 26th, it was already apparent how serious would be the task before this 2nd Corps, which covered all the rest of the army,

and, in a sense, the whole of the Anglo-French retirement. General Sir Horace Smith-Dorrien, who was here in command, was threatened with a disaster that might carry in its train disaster to the whole British contingent, and ultimately, perhaps, to the whole Franco-British line.

Although the German bodies which were attempting the outflanking had not yet all come up, the field artillery of no less than four German corps was already at work against this one body, and a general action was developing upon which might very well depend the fate of the campaign. Indeed, the reader will do well to fix his attention upon this day, Wednesday, the 26th August, as the key to all that followed. There are always to be found, in the history of war, places and times which are of this character—nuclei, as it were, round which the business of all that comes before and after seems to congregate. Of such, for instance, was the Friday before Waterloo, when Erlon's counter-orders ultimately decided the fate of Napoleon; and of such was Carnot's night march on October 15, 1793, which largely decided the fate of the revolutionary army.

The obvious action to take in such a position as that in which the 2nd Corps found themselves was to break contact with the enemy, to call for support from the 1st Corps, and to maintain the retreat as indefatigably as it had already been maintained in the preceding twenty-four hours.

But men have limits to their physical powers, which limits commonly appear sharply, not gradually, at the end of a great movement. The 1st Corps had been marching and fighting a day and a night, and that after a preceding whole day of retirement from before Mons. It was unable to execute a further effort. Further, the general in command of the 2nd Corps reported that the German pressure had advanced too far to permit of breaking contact in the face of such an attack.

It would have been of the utmost use if at this moment a large body of French cavalry—no less than three divisions—under General Sordet, could have intervened upon that critical moment, the morning of Wednesday, the 26th, to have covered the retirement of the 1st Corps.

They were in the neighbourhood ; the British commander had seen their commander in the course of the 25th, and had represented his need. Through some error or misfortune in the previous movement of this corps—such that its horses were incapable of further action through fatigue—it failed to appear upon the field in this all-important juncture, and General Sir Horace Smith-Dorrien was left facing overwhelming odds, which in artillery—the arm that was doing all the heavy work of that morning—were not less than four to one.

The fact that the retirement was at last made possible was due more than anything else to the handling of the British guns upon this day, and to the devotion with which the batteries sacrificed themselves to the covering of that movement ; while the cavalry, as in the preceding two days, co-operated in forming a screen for the retreat.

It was about half-past three in the afternoon when the general in command of this exposed left flank judged it possible to break contact, and to give the order for falling back. The experiment

—for it seems to have been no more secure than such a word suggests—was perilous in the extreme. It was not known whether the consequences of this fierce artillery duel against an enemy of four-fold superiority had been sufficient to forbid that enemy to make good the pursuit. Luckily, as the operation developed, it was apparent that the check inflicted upon such enormous odds by the British guns was sufficient for its purpose. The enemy had received losses that forbade him to move with the rapidity necessary to him if he was to decide the matter. He failed to press the retiring 2nd British Corps in any conclusive fashion: this 2nd Corps, the left wing, was saved; and with it the whole army, and perhaps the whole line.

The retreat of this body, which had thus covered all its comrades, continued under terrible conditions of strain (and after so heavy an action) right through the afternoon, and on hour after hour through the darkness; but though such an effort meant the loss of stragglers and of wounded, of guns whose teams had been destroyed, of material, and of all

that accompanies a perilous retreat, one may justly say that well before midnight of that Wednesday, the 26th, the operation had proved successful and its purpose was accomplished.

Two more days of almost equal strain were, as we shall see, to be suffered by the whole army before it had reached a natural obstacle behind which it could draw breath (the river Oise), and might fairly be regarded as no longer in peril of destruction; but the breaking point that had come on that Wednesday, the 26th, had been successfully passed without disaster, and had been so passed, in the main, by virtue of the guns.

This critical day, upon which depended the fortunes certainly of the British contingent, and in some degree of all the "operative corner" of the French plan, turned in favour of the Allies, not only through the military excellence of the action which was broken off by Sir Horace Smith-Dorrien during the afternoon, but also through the vigour and tenacity of the retreat.

I must here beg the reader's leave for a short digression in connection with

those two phrases—"in favour of," and "vigour." History in general treats a retirement, particularly a rapid retirement accompanied by heavy losses, as a disaster; and the conception that such a movement may seem to the military historian a success, and that the energy of its conduct is just as important as the energy of an assault, is unfamiliar to most students of civilian record. But I am writing here, though an elementary, yet a military history; and to the military historian a retreat may be just as much a factor in victory as an advance; while the energy and tenacity required for its carriage are, if anything, more important than the corresponding qualities required for an advance. And in the case of this critical day and a half, the Wednesday, August 26th, and the Wednesday and Thursday night, August 26th-27th, the preservation of the British forces, and to some extent of all that lay east of them, was made possible by the very fact that the retirement was prosecuted with the utmost rapidity and without a halt. Had the retreat been interrupted in the hope of making a stand,

or in the hope of repose, the whole army would have gone.

Throughout the night, then, with heavy losses from stragglers, and in one case with the surrounding and annihilation by wounds and capture of nearly a whole battalion (the Gordons), the retreat of the 2nd Corps proceeded, and, in line with it, the retreat of the 1st Corps to the east.

But this 1st Corps, though set an easier task than the 2nd (which, at the extreme of the line, was under the perpetual menace of development), did not retire without losses of a serious character. It was marching on Guise, just as the 2nd Corps to the west of it was marching across the watershed to St. Quentin. The Munster Fusiliers, who were on its extreme right, had halted for the night on that same evening of the 26th; for the 1st Corps, being less hard pressed, had more leisure for such repose. During the night a messenger was sent to this body with orders for the resumption of the march next morning. He was taken prisoner, and never reached his goal. The Munsters were attacked at

dawn by the German pursuit in greatly superior numbers, surrounded and destroyed, as the Gordons of the 2nd Corps had been; the unwounded remnant was compelled to surrender.

The whole of Thursday, the 27th, and Friday, the 28th of August, the British

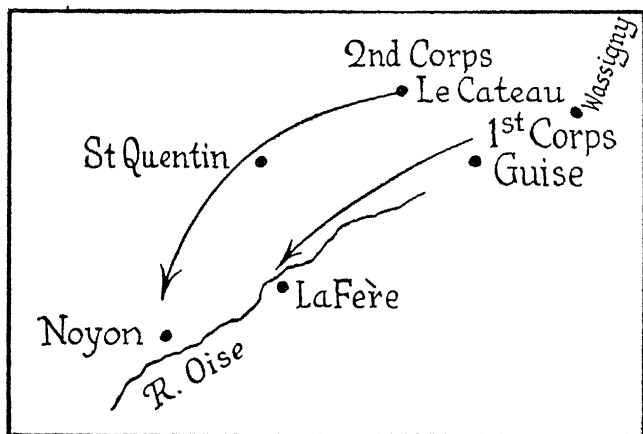

Sketch 58.

retreat continued, the 1st Corps following on at the valley of the Oise towards La Fère, while the 2nd Corps to the west passed St. Quentin, and made for Noyon, in the neighbourhood of the same river farther down; and on the night of that Friday the Expeditionary Force was at

last in line, and in some kind of order, organized for the first breathing space possible after so terrible an ordeal.

It is clear from the accompanying sketch map that the position the British had now reached gave to the whole

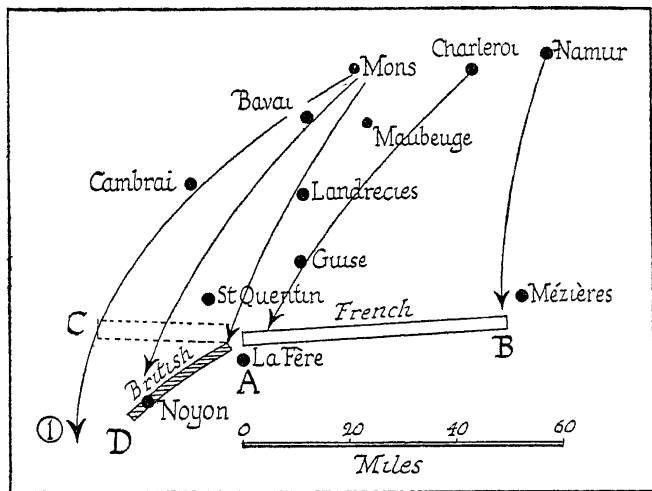

Sketch 59.

Allied force a bent contour. The French armies to the east lay along line AB, which, had it been directly prolonged, would have stretched towards C; but the British contingent, which, on account of its extreme position, had suffered most heavily, was turned right back on the

scheme AD, and even so, was still in some peril of being outflanked by the German forces along the arrow (1) to the west of it. At this moment the French, whose fortunes we shall next describe, found it possible to check the fury of the pursuit. The drive of the German masses, which had so nearly annihilated the British end of the line, was blocked, and the remainder of the great retreat followed a more orderly fashion, proceeded at a much slower rate, and approached that term at which a counter-offensive might be attempted.

The whole process may be compared to the flood of a very rapid tide, which, after the first few hours, is seen to relax its speed considerably, and to promise in the immediate future an ebb.

In order to appreciate how this was, let us next consider what the larger French forces to the east of the British had been doing. There are no details available, very few published records, and it will not be possible until an official history of the war appears to give more than the most general sketch of the French movements in this retreat ;

but the largest lines are sufficient for our judgment of the result.

It will be remembered that what I have called "the operative corner" of the Allied army had stood in the angle between the Sambre and the Meuse. It had consisted in the British contingent upon the left, or west, in front of Mons; the 5th French Army, composed of three army corps, under Lanrezac, to the east of it, along the Sambre, past Charleroi; and the 4th French Army, also of three army corps, under Langle, along the Middle Meuse, being in general disposition what we have upon the accompanying sketch. It had been attacked upon Saturday, the 22nd August, by seventeen German army corps—that is, by forces double its own. On that same day Namur, at the corner, had fallen into complete possession of the Germans, the French retreat had begun, and on the following day the English force had, after the regrettable delay of half a day, also begun its retirement.

We have seen that the British retirement (following the dotted lines upon Sketch 60) had reached, upon the Friday night, the position from Noyon to La

Fère, marked also in dots upon the sketch.

What had happened meanwhile to their French colleagues upon the east?

The first thing to note is that the fortress

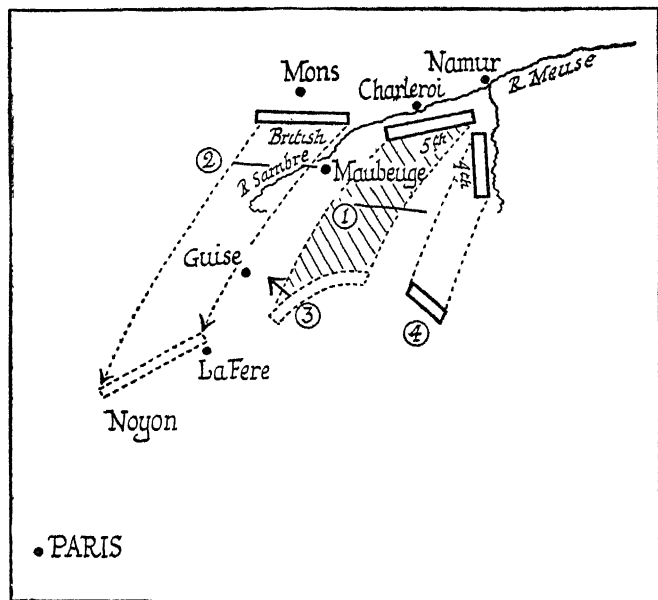

Sketch 60.

of Maubeuge, with its garrison of reserve and second line men, had, of course, been at once invested by the Germans when the British and French line had fallen behind it and left it isolated. The im-

perfection of this fortress I have already described, and the causes of that imperfection. Maubeuge commanded the great railway line leading from Belgium to Paris, which is the main avenue of supply for an invasion or for a retreat, running north-east to south-west on the Belgian frontier upon the capital.

The 5th French Army retired parallel to the British along the belt marked in Sketch Map 60 by diagonal lines. At first, as its retirement had begun earlier, it was behind, or to the south of, the British, who were thus left almost unsupported. It lay, for instance, on Monday, the 24th, much along the position 1, at which moment the British Army was lying along the position 2. That was the day on which the Germans attempted to drive the British into Maubeuge.

But during the succeeding two days the French 5th Army (to which the five corps, including the Prussian Guard, under Buelow, were opposed) held the enemy fairly well. They were losing, of course, heavily in stragglers, in abandoned wounded, and in guns; but their retreat was suffi-

ciently strongly organized to keep this section of the line well bent up northwards, and just before the British halted for their first breathing space along the line La Fère and Noyon, the French 5th Army attempted, and succeeded in, a sharp local attack against the superior forces that were pursuing them. This local attack was undertaken from about the position marked 3 on Sketch 60, and was directed against Guise. It was undertaken by the 1st and 3rd French Corps, under General Maunoury. He, acting under Lanrezac, gave such a blow to the Prussian Guard that he here bent the Prussian line right in.

Meanwhile the 4th French Army, which had also been retiring rapidly parallel to the 5th French Army, lay in line with it to the east along that continuation of 3 which I have marked with a 4 upon the sketch. Farther east the French armies, linking up the operative corner with the Alsace-Lorraine frontier, had also been driven back from the Upper Meuse, and upon Friday, the 28th of August, when the British halt had come between La Fère and Noyon (a line largely protected by the

Oise), the whole disposition of the Allied forces between the neighbourhood of Verdun and Noyon was much what is laid down in the accompanying sketch. At A were the British; at B the successful counter-offensive of the French 5th Army

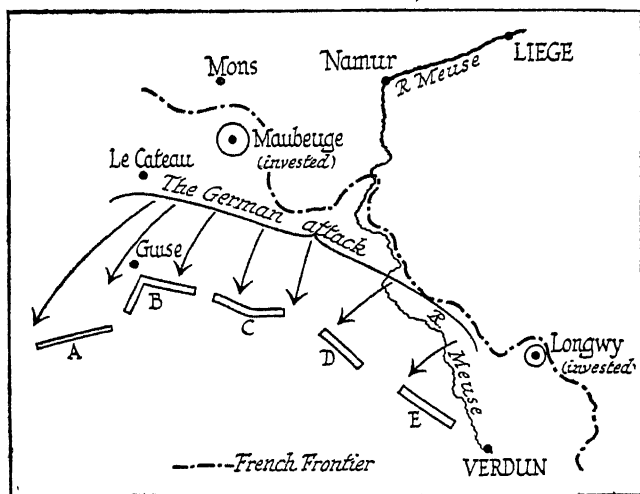

Sketch 61.

had checked and bent back the Prussian centre under von Buelow; at C, the last section of what had been the old operative corner, the army under Langle was thrust back to the position here shown, and pressed there by the Wurtembergers and the Saxons opposed to it. Mean-

while further French forces, D and E, had also been driven back from the Upper Meuse, and were retiring with Verdun as a pivot, leaving isolated the little frontier town of Longwy. This was not seriously fortified, had held out with only infantry work and small pieces, and had not been thought worthy of attack by a siege train.

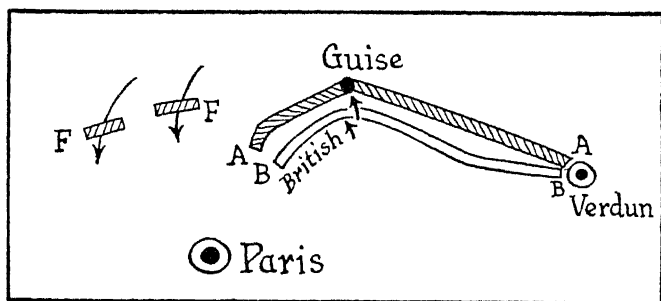

Sketch 62.

It surrendered to the Crown Prince upon Friday, 28th August.

On that date, then, the two opposing lines might be compared, the one to a great encircling arm AA, the elbow of which was bent at Guise, the other to a power BB which had struck into the hollow of the elbow, and might expect, with further success, to bend the arm so much more at that point as to embarrass its general sweep.

Those who saw the position as a whole on this Friday, the 28th of August, wondered whether or not the French Commander-in-chief would order the continuation of the successful local attack at Guise, and so attempt to break the whole German line. He did not give this order, and his reasons for retiring in the face of such an opportunity may be briefly stated thus :—

1. The French forces in line from Verdun to La Fère, and continued by the British contingent to the neighbourhood of Noyon, were still gravely inferior to the German forces opposed to them. Even, therefore, if the French success at Guise had been pushed farther, and had actually broken the German line, either half of the French line upon either side of the forward angle would have been heavily outnumbered by the two limbs of the enemy opposed to each, and that enemy might perfectly well have defeated, though separated, each portion of the force opposed to it.

2. To the west, at the position FF on Sketch 62, were acting large bodies of the enemy, which had swept, almost

without meeting resistance, through Arras to Amiens. Against that advance there was nothing but small garrisons of French Territorials, which were brushed aside without difficulty.

Now these bodies, though they were mainly of cavalry which were operating thus to the west, had already cut the main line of communications from Boulogne, upon which the British had hitherto depended, and were close enough to the Allied left flank to threaten it with envelopment, or, rather, to come up in aid of von Kluck at A, and make certain what he already could regard as probable—his power to get round the British, and turn the whole left of the Allied line.

3. More important even than these two first conclusive considerations was the fact that the French Commander-in-chief, had he proposed to follow up this success of his subordinate at Guise, would have had to change the whole of his general plan, and to waste, or at best to delay, the action of his chief factor in that plan. This chief factor was the great manœuvring mass behind the French line which had not yet come into play, and the advent of which,

304 A GENERAL SKETCH OF

at a chosen moment, was the very soul of the French strategy.

It is so essential to the comprehension of the campaign to seize this last point that, at the risk of repetition, I will re-

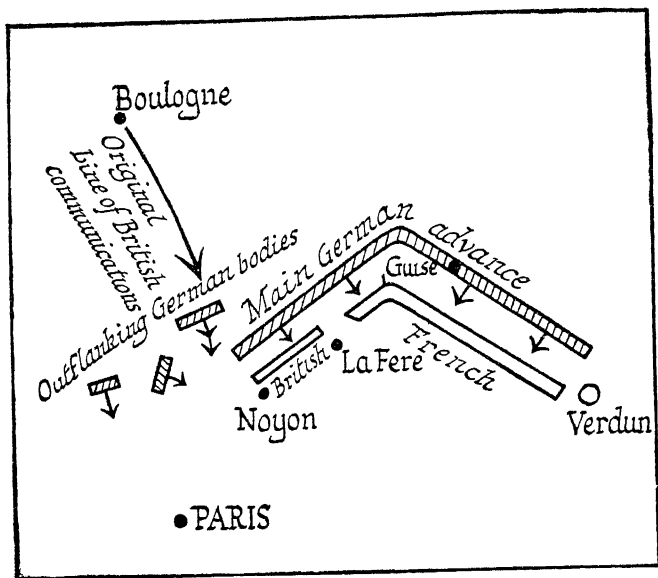

Sketch 63.

state for the reader the main elements of that strategy.

I have called it in the earlier pages of this book "the open strategic square," and I have shown how this theoretical arrangement was in practice complicated

and modified so that it came to mean, under the existing circumstances of the campaign, the deliberate thrusting forth of the fraction called "the operative corner," behind which larger masses, "the mass of manœuvre," were to come up in aid and assume the general counter-offensive when the operative corner should have drawn the enemy down to that position in which such a general counter-offensive would be most efficacious.

To concentrate the great mass of manœuvre was a business of some days, and having ordered its concentration in one district, it would be impossible to change the plan at a moment's notice. The district into which a great part of this mass of manœuvre had been concentrated—or, rather, was in course of concentration at this moment, the 28th August—was the district behind and in the neighbourhood of Paris. It lay far from the scene of operation at Guise. It was intended to come into play only when the general retreat should have reached a line stretching from Verdun to the neighbourhood of Paris itself. To have pursued the success at Guise, therefore, would have been to waste

all this great concentration of the mass of manœuvre which lay some days behind the existing line, and in particular to waste the large body which was being gathered behind and in the neighbourhood of Paris.

With these three main considerations in mind, and in particular the third, which was far the most important, General Joffre determined to give up the advantage obtained at Guise, to order the two successful army corps under Maunoury, who had knocked the Prussian Guard at that point, to retire, and to continue the general retreat until the Allied line should be evenly stretched from Paris to Verdun. The whole situation may be put in a diagram as follows: You have the Allied line in an angle, ABC. You have opposed to it the much larger German forces in a corresponding angle, DEF. Farther east you have a continuation of the French line, more or less immovable, on the fortified frontier of Alsace-Lorraine at M, opposed by a greater immovable German force at N. At P you have coming up as far as Amiens large German bodies operating in the west, and at Q a small newly-formed French body, the 6th French

Army, supporting the exposed flank of the British contingent at A, near Noyon. Meanwhile you have directed towards S, behind Paris, and coming up at sundry other points, a concentration of the mass of manœuvre.

It is evident that if the French offensive

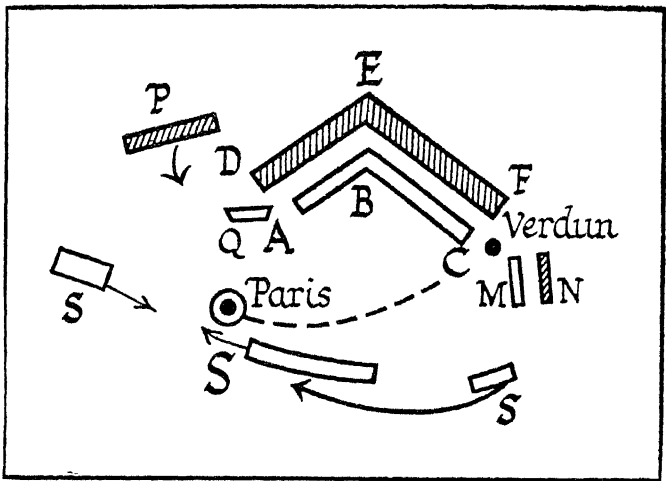

Sketch 64.

at B which has successfully pushed in the German elbow at E round Guise is still sent forward, and even succeeds in breaking the German line at E, "the elbow," the two limbs into which the Germans will be divided, DE and EF, are each

superior in number to the forces opposed to them, and that DE in particular, with the help of P, may very probably turn AB and its new small supporter at Q, roll it up, and begin a decisive victory, while the other large German force, EF, may press back or pierce the smaller opposed French force, BC.

Meanwhile you would not only be risking this peril, but you would also be wasting your great mass of manœuvre, SS, which is still in process of concentration, most of it behind Paris, and which could not possibly come into play in useful time at E.

It is far better to pursue the original plan to continue the retreat as far as the dotted line from Paris to Verdun, where you will have the whole German force at its farthest limit of effort and corresponding exhaustion, and where you will have, after the salutary delay of the few intervening days, your large mass of manœuvre, SS, close by to Paris and ready to strike.

From such a diagram we see the wisdom of the decision that was taken to continue the retirement, and the fruits which that decision was to bear.

The whole episode is most eminently characteristic of the French military temper, which has throughout the whole of French history played this kind of game, and invariably been successful when it has attained success from a concentration of energy upon purely military objects and a sacrificing of every domestic consideration to the single object of victory in foreign war.

It is an almost invariable rule in French history that when the military temper of the nation is allowed free play its success is assured, and that only when the cross-current of a political object disturbs this temper do the French fail, as they failed in 1870, as they failed in 1812, or as they failed in the Italian expeditions of the Renaissance. By geographical accident, coupled with the conditions, economic and other, to which their aggression gives rise, the French are nearly always numerically inferior at the beginning of a campaign. They have almost invariably begun their great wars with defeats and retirements. They have only succeeded when a patient, tenacious, and consistently military policy has given them the

requisite delay to achieve a defensive-offensive plan. It was so against Otto the Second a thousand years ago ; it was so in the wars of the Revolution ; it was so in this enormous campaign of 1914. There is in their two thousand years of constant fighting one great and salutary exception to the rule—their failure against Cæsar ; from which failure they date the strength of their Roman tradition—still vigorous.

The minor fortified posts lying behind the French line were not defended. Upon 29th August the French centre fell back behind Rethel, the Germans crossed the Aisne, occupied Rheims and Châlons, while the British contingent on the left and the French 6th Army now protecting its flank continued also to fall back towards Paris. And on Sedan day, 2nd September, we may regard the great movement as having reached its end.

The German advance had nowhere hesitated, save at Guise, and the French retirement after their success at Guise can only have seemed to the German commanders a further French defeat.

Those commanders knew their overwhelming numerical superiority against the total of the Allied forces—a superiority of some 60 per cent. They may have guessed that the French were keeping a considerable reserve; but in their imagination that reserve was thought far less than it really was, for they could hardly believe that under the strain of the great retreat the French commanders would have had the implacable fortitude which permitted them to spare for further effort the reinforcements of which the retiring army seemed in vital and even in despairing need.

Upon this anniversary of Sedan day it cannot but have appeared to the Great General Staff of the enemy that the purpose of their great effort in the West was already achieved.

They had reached the gates of Paris. They had, indeed, not yet destroyed the enemy's main army in the field, but they had swept up garrison after garrison; they had captured, perhaps, 150,000 wounded and unwounded men; their progress had been that of a whirlwind, and had been marked by a bewildering

312 A GENERAL SKETCH OF

series of incessant victories. They were now in such a situation that either they could proceed to the reduction of the forts outside Paris (to which their experience of their hitherto immediate reduction of every other permanent work

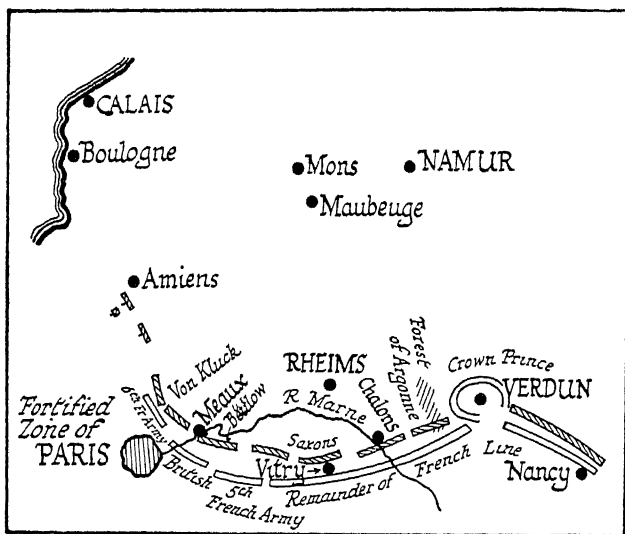

Sketch 65.

left them contemptuous), or they could proceed to break at will the insufficient line opposed to them.

They stood, on this anniversary of Sedan, in the general situation apparent on the accompanying sketch. The 6th

French Army was forced back right upon the outer works of Paris ; the British contingent, to its right, lay now beyond the Marne ; the 5th French Army, to its right again, close along the Seine ; the 4th and 3rd continuing the great bow up to the neighbourhood of Verdun, three-quarters of the way round which fortress the Crown Prince had now encircled ; and in front of this bent line, in numbers quite double its effectives, pressed the great German front over 150 miles of French ground. Upon the left or west of the Allies—the German right—stood the main army of von Kluck, the 1st, with its supporters to the north and west, that had already pressed through Amiens. Immediately to the east of this, von Buelow, with the 2nd Army, continued the line. The Saxons and the Wurtembergers, a 3rd Army, pressed at the lowest point of the curve in occupation of Vitry. To the east, again, beyond and in the Argonne, the army of the Crown Prince of Prussia was upon the point of reducing Verdun, the permanent works of which fortress had already suffered the first days of that bombardment from

the new German siege train which had hitherto at every experiment completely destroyed the defence in a few hours. If we take for the terminal of this first chapter in the Great War the morning of 4th September, we may perceive how nearly the enemy had achieved his object, to which there now stood as a threat nothing more but the French reserves, unexpected in magnitude, though their presence was already discovered, which had for the most part been gathered in the neighbourhood of and behind the fortified zone of Paris.

With this position, of what it meant in immediate alternatives to the enemy, I will deal a few pages on at the close of this book, when I will also consider in one conspectus on the map the whole of that ten days' sweep down from the north, and summarize its effect upon the Allied attitude towards the next phase of the war.

But to understand a campaign, one must seize not only the topographical positions of troops, nor only their number: one must also gauge the temper of their commanders and of the political opinion at home behind them, for upon this

moral factor everything ultimately depends. The men that fight are living men, and the motive power is the soul.

It is, therefore, necessary for the reader to appreciate at this terminal date, September 2-4, the moral strength of the enemy, and to comprehend in what mood of confidence the Germans now lay. With this object we must add to the story of the advance on Paris the subsidiary events which had accompanied that great sweep into the West. We must turn to the "holding up of Russia" upon the East by the Austrian forces, and see how the partial failure of this effort (news of which was just reaching the Western armies) was quite eclipsed by the splendid tidings of Tannenberg. We must see with German eyes the secondary but brilliant victory in front of Metz; we must stand in their shoes to feel as they did the clearing of Alsace, and to comprehend with what contempt they must have watched the false picture of the war which the governments and the press of the Allies, particularly in Britain, presented to public opinion in

their doomed territories ; and we must, in general, grasp the now apocalyptic temper of the nervous, over-strained industrialized population which is the tissue of modern Germany.

Not until we have a good general aspect of that mood can we understand either the war at this turning-point in its fortunes, or the future developments which will be traced in the succeeding volumes of this series.

I will, therefore, now turn to the three main elements productive of that mood in their historical order : the Battle of Metz, the Austrian operations against Russia, and, lastly, the great victory of Tannenberg in East Prussia, before concluding this volume with a summary of the whole situation in those first days of September, just before the tide turned.

THE BATTLE OF METZ.

The Battle of Metz, though quite subsidiary to the general operations of the war, and upon a scale which later operations have dwarfed, will be mentioned with special emphasis in any just account

of the great war on account of its moral significance.

It took place before the main shock of the armies ; it had no decisive effect upon the future of the campaign ; but it was of the very highest weight, informing the German mind, and leading it into that attitude of violent exaltation on which I shall later insist in these pages, and which largely determined all the first months of the war, with their enormous consequences for the future. For the action in front of Metz was the first pitched battle fought in Western Europe during our generation, and to an unexpected degree it fulfilled in its narrow area all the dreams upon which military Germany had been nourished for forty years. It thrilled the whole nation with the news, at the very outset of hostilities, of a sharp and glorious victory ; it seemed a presage of far more to come. The Battle of Metz was the limited foundation upon which was rapidly erected that triumphant mood that lasted long after the tide had turned, and that matured, when bad blundering had lost the victory in the West, into the un-

soldierly, muddled hope that could fail to win, and yet somehow not lose, a campaign.

We have seen that the disposition of the French armies at the moment when the shock was being delivered through Belgium involved along the frontiers of Alsace-Lorraine the presence of considerable forces. These, once the operative corner had taken the shock, formed part of the mass of manœuvre, and were destined in large part to swing up in aid of the men retreating from the Sambre.

But in the very first days of the war, before the main blow had fallen, and when the French General Staff were still in doubt as to precisely where the blow *would* fall, considerable bodies had been operating in Alsace and over the Lorraine frontier. The whole range of the Vosges was carried in the second week after the British declaration of war—that is, between 10th August and 15th August. Mulhouse was occupied ; upon Monday, the 17th of August, Saarburg, the most important railway junction between Strassburg and Metz, was in French hands. Up to that date, though such compara-

tively small forces were involved, the French had possessed a very decisive numerical superiority. It was not des-

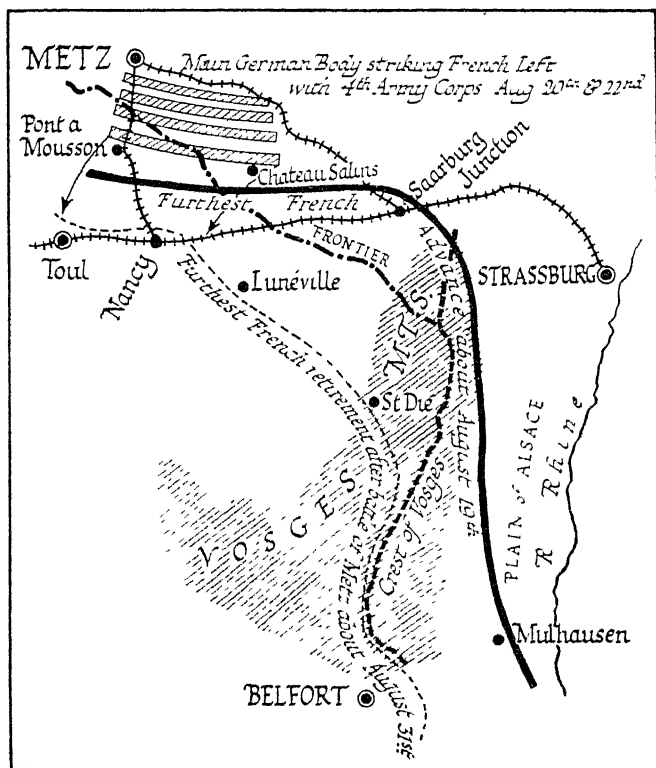

Sketch 66.

tined to last, for there was moving down from the north the now mobilized strength of Germany in this region; and a blow

struck against the French left, with no less than four army corps, was speedily to decide the issue upon this subsidiary front.

This great force was based upon Metz, from which fortress the action will presumably take its name in history. It stretched upon the 20th of August from the north of Pont-à-Mousson to beyond Château Salins. Before this overwhelming advance the French left rapidly retired. It did not retire quickly enough, and one portion of the French force—it is believed the 15th Division (that is, the first division of the 15th Army Corps)—failed in its task of supporting the shock.

Details of the action are wholly lacking. We depend even for what may be said at this date upon little more than rumour. The Germans claimed a capture of ten batteries and of the equivalent of as many battalions, and many colours. Upon the 21st the whole French left fell back, carrying with them as a necessary consequence the centre in the Vosges Mountains and the right upon the plains of Alsace. So rapid was the retreat that

upon the 22nd of August the Bavarians were at Lunéville, and marching on Nancy ; the extreme right of the German line had come within range of the forts north of Toul ; and in those same hours during which, on that same Saturday, the 22nd of August, the 5th French Army in the north fell back at the news of Namur and lost the Sambre, those forces on the borders of Alsace-Lorraine had lost all the first advantages of their thrust into the lost provinces, had suffered defeat in the first striking action of the war, and had put Nancy in peril.

Nancy itself was saved. The French counter-offensive was organized on the 23rd of August, at a moment when the German line lay from St. Dié northwards and westwards up to positions just in front of Nancy. It was delivered about a week later. That counter-offensive which ultimately saved Nancy belongs to the next volume, for it did not develop its strength until after Sedan Day, and after the end of the great sweep on Paris.

The situation, then, in this field (the very names of which have such great moral effects upon the French and the

German minds) was, by the 2nd of September, as follows :—

The French had suffered in the first considerable action of the war a disaster. They had lost their foothold in the annexed provinces. They had put the capital of French Lorraine, Nancy, in instant peril. They had fallen back from the Vosges. They were beginning, with grave doubts of its success, a counter-offensive, to keep the enemy, if possible, from entering Nancy. They had lost thousands of men, many colours, and scores of guns, and all Germany was full of the news.

LEMBERG.

The foundation of the Germanic plan upon the Eastern front at the origin of the war was, as we have said, the holding up of Russia during her necessarily slow mobilization, while the decisive stroke was delivered in the West.

That is the largest view of the matter.

In more detail, we know that the main part of this task was entrusted to the Austro-Hungarian forces. The German forces had indeed entered and occupied

the west fringe of Russian Poland, seizing the small industrial belt which lies immediately east of Silesia, and the two towns of Czestochowa and Kalish—the latter, in the very centre of the bend of the frontier,

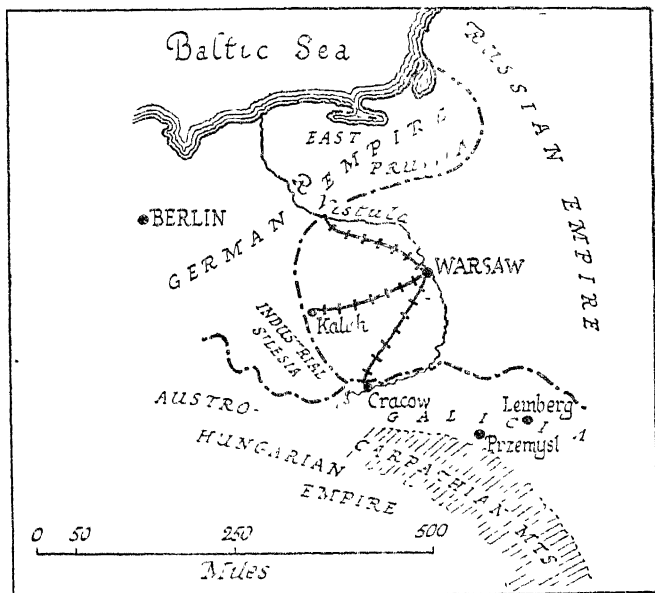

Sketch 67.

because it was a big railway depot, and, as it were, a gage of invasion; the former, both because the holding of one line demanded it (if Kalish and the industrial portion were held), and because

Czestochowa being the principal shrine of the Poles, some strange notion may have passed through the German mind that the presence therein of Prussian officers would cajole the Poles into an action against Russia. If this were part of the motive (and probably it was), it would be a parallel to many another irony in the present campaign and its preliminaries, proceeding from the incapacity of the enemy to gauge the subtler and more profound forces of a civilization to which it is a stranger.

This local German move was almost entirely political. The main task, as I have said, was left to the Austrians farther south; and, proceeding to further detail, we must see the Austrians stretched in a line from near the middle Carpathians past the neighbourhood of Tomasow towards Tarnow, and this line distinctly divided into two armies, a northern and a southern. The two met in an angle in front of the great fortress of Przemyśl. The northern, or first, army faced, as will be seen, directly towards the Russian frontier. It was the operative wing; upon its immediate action and on the rapidity of the blow it

was to deliver depended the success of this first chapter in the Eastern war.

The southern, or second, army, which stretched all along the Galician plain at

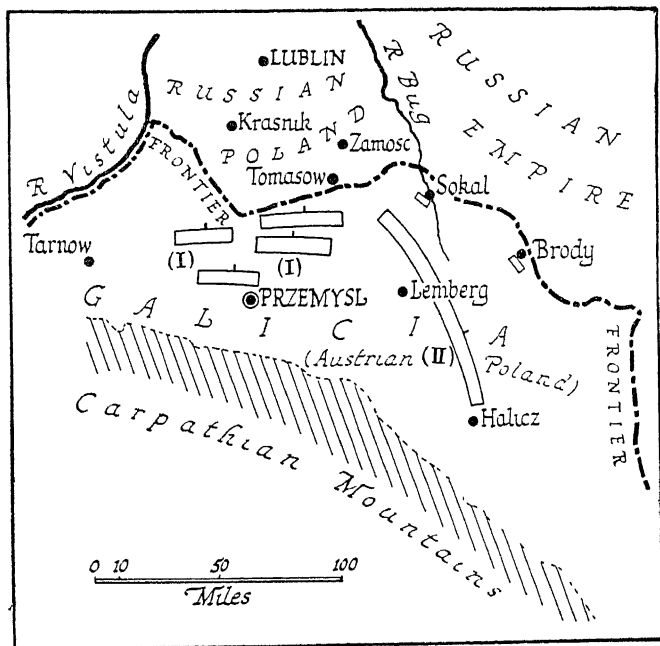

Sketch 68.

the foot of the Carpathians to the town of Halicz, had for its mission the protection of the first army from the south. It was known, or expected, that the first army would advance right into Russian

Poland, with but inferior forces in front of it. It was feared, however, that the main Russian concentration to the south-east of it might turn its right flank. The business of the second army was to prevent this. The first army (I), being the operative body, was more homogeneous in race, more picked in material than the second (II), the latter containing many elements from the southern parts of the empire, including perhaps not a few disaffected contingents, such as certain regiments of Italian origin from the Adriatic border.

So far as we can judge, perhaps—and it is a very rough estimate—we may put the whole body which Austria-Hungary was thus moving in the first phase of the war beyond the Carpathians at more than 750,000, but less than 1,000,000 men. Call the mass 800,000, and one would not be far wrong. Of this mass quite a quarter lay in reserve near the mountains behind the first army. The remaining three-quarters, or 600,000 men, were fairly evenly divided between the two groups of the first and of the second army—the first, or northern, one being under the

command of Dankl, the second under that of von Auffenberg. Each of these forces was based upon one group of depots of particular importance, the northern operative army (I) relying upon Przemyśl, and the southern one (II) upon Lemberg.

It was less than a week after the first German advance bodies had taken the outer forts of Liége when Dankl crossed the frontier, heading, with his centre, towards Krosnik and farther towards Lublin. His troops were in Russian territory upon the Monday evening or the Tuesday, 10th-11th August.

The second army meanwhile stood fulfilling its rôle of awaiting and containing any Russians that might strike in upon the south. It had advanced no more than watching bodies towards the frontier, such as the 35th Regiment of the Austrian Landwehr, which occupied Sokal, and smaller units cordoned out southward between that town and Brody. Here, at the outset of the large operations that were to follow, it is important for the reader to note that everything depended upon the resisting power of the second, or southern, army.

Observe the problem. Two men, a left-

hand man and a right-hand man, go out to engage two other men whom they hope and believe to be unready. The left-hand man is particularly confident of being able to drive back his opponent, but he knows that sooner or later upon his right the second enemy, a stronger man, may come in and disturb his action. He says therefore to his right-hand companion: "Stand firm and engage and contain the energy of your opponent until I have finished with mine. When I have done that, I shall turn round towards you, and between us we will finish the second man."

Seeing the paucity of Russian communications, and the physical necessity under which the Russians were, on account of the position of their depots and centres of mobilization, of first putting the mass of their men on the south, the physical impossibility under which they lay of putting the mass of their men in the north for the moment, the plan was a sound one; *but* its success depended entirely upon the tenacity of the second Austrian army, which would have to meet large, and might have to meet superior, numbers.

The first army went forward with very

little loss and against very little resistance. The Russian forces which were against it, which we may call the first Russian army, were inferior in number, and fell back, though not rapidly, towards the Bug. It relied to some extent in this movement upon the protection afforded by the forts of Zamosc, but it was never in any serious danger until, or unless, things went wrong in the south. The Austrians remained in contact (but no more), turned somewhat eastward in order to keep hold of the foe, when their advance was checked by the news, first of unexpected Russian strength, later of overwhelming Russian advances towards the south. Long before the third week in August, the first Austrian army was compelled to check its advance upon the news reaching it from the second, and its fortunes, in what it had intended to be a successful invasion of Russian Poland, had ended. For the whole meaning of the first Galician campaign turns after the 14th of August upon the great Russian advance in the south.

It was upon that day, August 14, that the Russian force, under General Russky (which we will call the second army),

crossed the frontier. Its right occupied Sokal, its centre left moved in line with the right upon von Auffenberg's force directly before it.

The Russian mobilization had proceeded at a greater pace than the enemy had allowed for. The Russian numbers expected in this field appeared in far greater strength than this expectation had allowed for, and it was soon apparent that von Auffenberg's command would have to resist very heavy pressure.

But it would be an error to imagine, as was too hastily concluded in the press of Western Europe at the time, that this pressure upon the front of the second Austrian army, with its dogged day after day fighting and mile by mile advance, was the principal deciding factor in the issue. That deciding factor was, in fact, the appearance upon the right flank of von Auffenberg of yet another Russian army (which we will call the third) under Brussilov. It was the menace of this force, unexpected, or at least unexpected in its great strength, which really determined the issue, though this was again affected by the tardiness of the Austrian retire-

ment. Russky's direct advance upon the front of his enemy extended for a week. It had begun when it had destroyed the frontier posts upon Friday, the 14th. It was continued until the evening of the succeeding Thursday, regularly, slowly, but without intermission. It stood upon the Friday, the 21st—the day on which the first shots were fired at the main Franco-British forces in the West, and the day on which the first shell fell into Charleroi station—not more than one day's cavalry advance from the outer works of Lemberg, but it was just in that week-end that the pressure of Brussilov began to be felt.

This third Russian army had come up from the south-east, supplied by the main Odessa railway through Tarnopol. It was manifestly threatening the right flank of von Auffenberg, and if a guess may be hazarded upon operations on which we have so little detail as yet, and which took place so far from our own standpoint, the error of the Austrian general seems to have consisted in believing that he could maintain himself against this flank attack. If this were the case (and it

is the most probable explanation of what followed), the error would have been due to the same cause which affected all Austrian plans in these first days of the war—the mistake as to the rapidity with which Russia would complete her preparations.

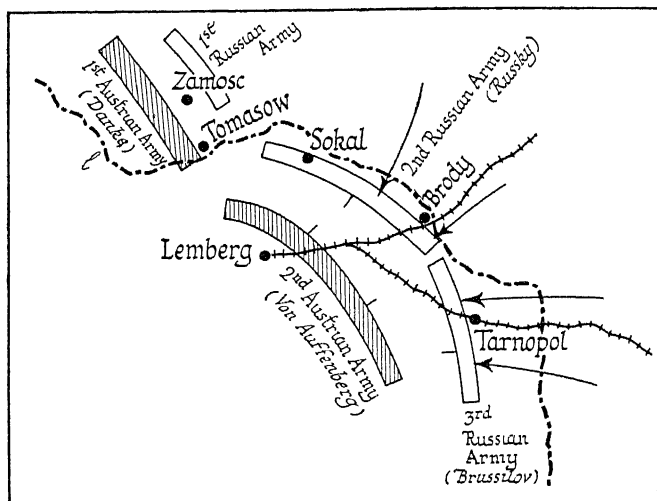

Sketch 69.

The first outpost actions with the enemy, and even the more vigorous struggles when full contact had been established with this third army arrived thus from the south-east, only led the Austrian commander deeper into his mistaken calculation; for upon the Sun-

day, August 23rd, a local success was achieved which seems to be magnified by the Austrians into a decisive check administered to the enemy. If this was their view, they were soon to be undeceived. In those very days which saw the greatest peril in the West, the last days of August, during which the Franco-British Allies were falling back from the Sambre, pursued by the numbers we have seen upon an earlier page, the third and the second Russian armies effected their junction, the moment of their first joining hands being apparently that same Monday, the 24th of August, during which Sir John French was falling back upon Maubeuge. By the middle of the ensuing week they had already advanced with a very heavy numerical superiority upon the part of the Russians, which threatened to involve the Austrian second army in disaster. If that went, the first army was at the mercy of the victors upon the south, and with every day that passed the chance of collapse increased. Now, too late (so far as we can judge), the second Austrian army disposed itself for retreat, but that retreat was not allowed to proceed in the orderly fashion which its

commander had decided, and in the event part of it turned into a rout, all of it developed into a definite disaster for the enemy, and as conspicuous a success for our ally. That this success was not decisive, as this great war must count decisions, the reader will perceive before its description is concluded; but it set a stamp upon the whole of the war in the East, which months of fighting have not removed but rather accentuated. It delivered the province of Galicia into the hands of Russia, it brought that Power to the Carpathians, it ultimately compelled Germany to decide upon very vigorous action of her own immediately in Poland, and it may therefore be justly said to have changed the face of the war.

To this great series of actions, which history will probably know by the name of Lemberg, we will now turn.

When this large Russian movement against the right of von Auffenberg's army, and the considerable Russian concentration there, was clearly discerned, the Austrian force was immediately augmented, and it was not until after the first stages of the conflict we are about to describe that

it counted the full numbers mentioned above. But, even so reinforced, it was inadequate for the very heavy task which there fell upon it. It is not to be denied that its heterogeneous composition—that is, its necessary weakness in quality—affected its value ; but the principal factor in its ill success was still the superiority of Russian numbers in this field, and this, in its turn, proceeded from a rapidity and completeness in the Russian mobilization for which the enemy had never made provision.

The action of the Russian left against von Auffenberg was twofold : Russky, from the north, was coming across the river Bug, and struck an Austrian entrenched line in front of Lemberg. His numbers permitted him to turn that entrenched line, or, at any rate, to threaten its turning, for Russky's right stretched almost to within cavalry touch of Tomasow. In combination with this movement, and strictly synchronizing with it, Brussilov was advancing from the Sereth River. Both these movements were being carried out full during the last days of August.

It was on Friday, the 28th of that

336 A GENERAL SKETCH OF

month, that Tarnopol fell, as we have seen, into the hands of the Russians, and that Brussilov was, therefore, able to effect his junction with Russky in the

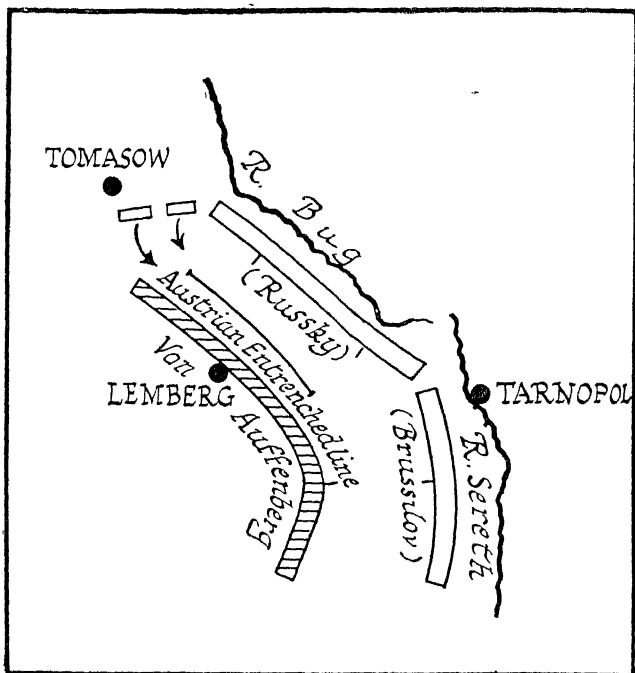

Sketch 70.

north, and this success was the occasion of the first of those bayonet actions on a large scale wherein the Russians throughout the war continued to show such con-

siderable personal superiority over their opponents.

When Tarnopol had gone, not on account of the loss of their geographical point, but because its occupation rendered the junction of the Russian armies possible, and their advance in one great concave line upon Lemberg, it was no longer doubtful that von Auffenberg had lost this preliminary campaign.

There are moments in war where the historian can fix a turning-point, although the decision itself shall not yet have been reached. Thus, in the campaign of 1793 between the French Revolution and its enemies, Turcoing was not a decisive action, but it was the necessary breeder of the decisive actions that followed. And in the same way Tarnopol, though but a local success, decided Lemberg. In the last days of August all von Auffenberg's right had to fall back rather rapidly upon entrenched positions to the south and east of Lemberg itself, just as his left had had to fall back on similar positions against Russky.

The action for Lemberg itself opened, by a curious coincidence, the campaign

which was the anniversary of the first fighting round Sedan, and closed precisely at the moment when the tide of German advance in the West was turned.

Forty-eight hours decided the issue. It was, perhaps, Russky's continual extended threat to envelop the left of the Austrian position and to come upon Auffenberg's communications which was the chief factor in the result; but that result was, after the junction of the two Russian armies, no longer really in doubt. The first heavy assault upon the trenches had taken place upon the Wednesday morning at dawn; before nightfall of Thursday the two extremes of the Austrian line were bent back into such a horseshoe that any further delay would have involved complete disaster. It is true that the central trenches in front—that is, to the east of the great town—still held secure, and had not, indeed, been severely tried. But it remains true that von Auffenberg had committed the serious error of risking defeat in front of such a city. And here some digression upon the nature of this operation may be of service to the reader, because it is one which reoccurs more than

once in the first phases of the war, and must, in the nature of things, occur over and over again before the end of it.

Examples of it already appeared in the first six months of the war, in the case of Lille and in the case of Lodz; and it is a necessarily recurrent case in all modern warfare.

A great *modern* town, particularly if it has valuable industries, is a lure as powerful over the modern commander as was a capital or the seat of any government or even a fortress for those of earlier times. To abandon such a centre is to let fall into the enemy's hands opportunities for provisionment and *machinery* for his further supply; it is to allow great numbers of one's nationals to pass as hostages into his power; it is nearly always to give up to him the junction of several great railways; it is to permit him to levy heavy indemnities, and even, if he is in such a temper, to destroy in great quantities the accumulated wealth of the past.

On account of all this, it requires a single eye to the larger issues of war, and a sort of fanaticism for pure strategy in a commander before he will consent to fall

behind a position of such political and material value, and to let it fall to his opponent.

But, on the other hand, such a position is as bad in strategical value as it is good in material and political value.

If you suffer defeat in front of a great modern town, and have to retreat through it under the blows of the victorious enemy, you are in the worst possible position for conducting that retreat. The streets of the town (but few of which will run parallel to your course and can, therefore, serve as avenues of escape for your army) are so many defiles in which your columns will get hopelessly congested. The operation may be compared to the pouring of too much liquid into a funnel which has too small an orifice. Masses of your transport will remain clogged outside the place; you run the risk of a partial and perhaps of a complete disaster as the enemy presses on.

There is very much more than this. A great town cannot but contain, if you have long occupied it, the material of your organization; you will probably abandon documents which the enemy should not

see. You will certainly, in the pressure of such a flight, lose accumulated stores. Again, the transverse streets are so many points of "leakage," into which your congested columns will bulge out and get confused. Again, you will be almost necessarily dealing with the complication of a mass of civilian conditions which should never be allowed to interrupt a military operation.

In general, to fight in front of a great town, when the chances are against you, is as great an error as to fight in front of a marsh with few causeways; so far as mere topography is concerned, it is a greater error still.

Lemberg did not, indeed, fulfil all these conditions. It is very large (not far from a quarter of a million people), with all its suburbs it is nearly two miles in extreme extent, and its older or central part is a confusion of narrow streets; but it is not highly industrialized, and the position of the Austrian armies was such that the retreat could be effected mainly from either side of the built area, particularly as the main enemy pressure had not come in front of the city along the Busk Road,

but far to the east and south in the open field. But Lemberg was an exceedingly important railway centre (seven lines converge there), and it contained an immense amount of war munitions. When, therefore, the retreat was tardily undertaken, the fact that the more precipitate retirement had begun in front of the city and not behind it was of considerable effect in what followed.

To some extent von Auffenberg, in spite of the tardiness of his decision to retire, had protected his retreat. The main line of that retreat was established for him, of course, by the main Galician railway, which runs back from Lemberg to Przemyśl. He prepared a position some two days' march behind Lemberg, and defended with a rearguard at Grodek the belated withdrawal of his main force. But from the nature of the Russian advance, Russky, upon von Auffenberg's left, perpetually threatened this railway; and Brussilov, upon his right, pressed the rapidly-melting mass of the varied contingents opposed to him through the difficult, hilly, and woody country of the foothills.

It was upon the Friday, September 4th, that the Austrian evacuation of Lemberg was complete, and that the Russian administration was established in the town. Before Monday, the 7th, the Austrian right had already half converted their retirement into a rout, and the great

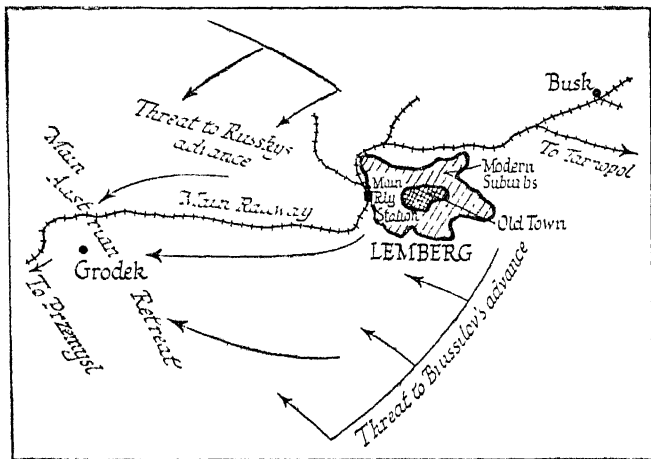

Sketch 71.

captures of prisoners and of guns had begun. That important arm, the irregular light cavalry of the Russians, notably the great Cossack contingent, found its opportunity, and the captures began upon a scale far exceeding anything which the war had hitherto shown or was to show

for at least the next six months. The matter is of more importance, to our judgment of the war, in its quality than in its scale. In the very same week at Tannenberg nearly as many Russians had been eliminated from the Russian forces as Austrians were here eliminated from the Austrian forces. But the point is that, whereas in the Battle of Tannenberg envelopment, with its consequent slaughter of men who cannot escape and its wholesale captures, left the rest of the Russian army with its *moral* intact, the Austrian losses were the product of a partial dissolution, and affected the whole of their southern army. First and last one-third of it had fallen *as prisoners* into Russian hands, apart from the enormous number of killed and removed wounded. It could only just be said that that army remained in being upon Monday, the 7th September, with which date this section of my work ends. The other Austrian army to the north, its flank thus uncovered, was compelled to fall back rapidly, though the forces in front of it were small; and the Austro-Hungarian service never fully recovered from this great blow.

TANNENBERG.

The province of East Prussia is of a character peculiar in the German Empire and in Europe.

That character must be grasped if the reader is to understand what fortunes attended the war in this region; for it is a district which in its history, in its political value, and in its geographical arrangements has very powerfully affected the whole of the campaign.

Historically this district is the cradle of that mixed race whose strict, narrow, highly defined, but quite uncreative policy has now piqued, now alarmed, civilized Europe for almost two hundred years.

The Prussian, or rather the Prussian aristocracy, which, by achieving the leadership of Germany, has flung so heavy a mass at Europe, originated in the rough admixture of certain West German and Christian knights with the vague pagan population of the Eastern Baltic plain, which, until almost the close of the Middle Ages, was still a field for missionary effort and for crusade. It was the business of the Teutonic knights to tame this march of

346 A GENERAL SKETCH OF

Christendom. They accomplished their work almost out of sight of the governing

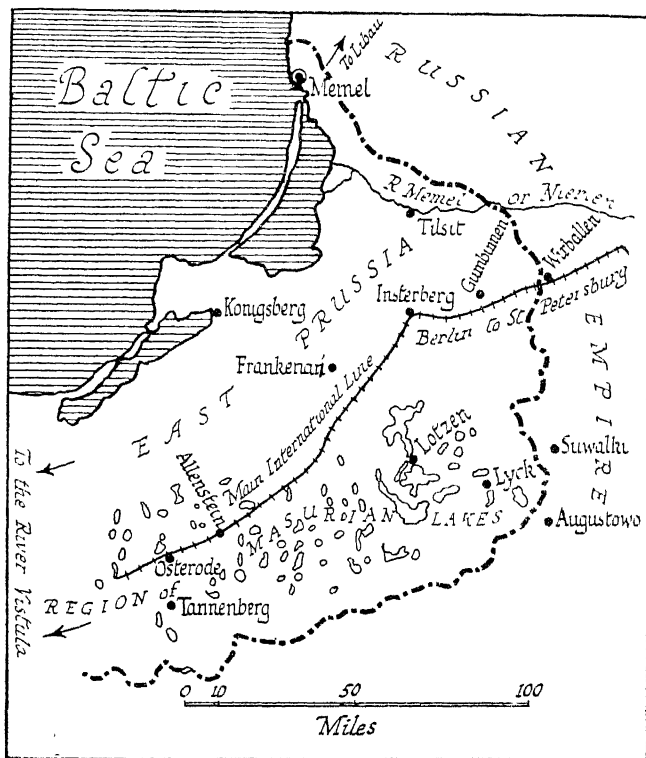

Sketch 72.

empire, the Papacy, and Christendom in general, with what infamies history records. The district thus occupied was not within

the belt of that high Polish culture which is one of the glories of Europe. Nations may not inexactly be divided into those who seek and those who avoid the sea. The Poles are of the latter type. This belt, therefore, of *Borussia* (whence our word Prussia is derived)—roughly from the Vistula up on to the Bight of Libau—was held by the Teutonic knights in a sort of savage independence. The Christian faith, which it had been their pretext and at first their motive to spread, took little root; but they did open those avenues whereby the civilization which Germany itself had absorbed from the south and west could filter in; and the northern part of the district, that along the sea (which is the least marshy, and, as that poor country goes, the least barren), was from the close of the Middle Ages German-owned, though for some generations nominally adherent to the Polish crown. The Polish race extended no farther northward in the present province than the lake country of its southern half, and even there suffered an admixture of Lithuanian and German blood.

That lake country well merits a par-

ticular description, for its topography has powerfully affected the war in the East; but for the moment we must chiefly grasp the political character following upon the history of this land. The chief noble of "Borussia," the governing duke, acquired, not from the empire nor perhaps in the eyes of Europe, but from the Polish monarchy, the title of king, and it must never be forgotten that the capital at Berlin, and the "Mark"—that is, the frontier march—of Brandenburg, though now the centre, are neither the origins nor the pride of the Hohenzollern power. They were kings of Prussia because Prussia was extraneous to the European system. There came a moment, as I have pointed out in an earlier page in this book, when the Prussian kingship and the electorate of Brandenburg coincided in one person. All men of education know, and all men whatsoever feel, what influence an historical origin will have upon national outlook. East Prussia, therefore, remains to-day something of a political fetish. Its towns may be called colonies of the Germans, the birthplaces or the residences of men famous in the German story. Its country-

sides, although still largely inhabited by a population of servile memories and habits not thoroughly welded with their masters, do not take up great space in the view the German takes of the region. He sees rather the German landowner, the German bailiff, the German schoolmaster, and the numerous German tenants of the wealthier type who, though a minority, form the chief part of this social system. We shall see later what this miscalculation cost the great landowners during the Russian invasion, but we must note in passing that it is a miscalculation common to every people. Only that which is articulate in the States stands out large in the social perspective during periods of order and of peace.

The Prussian royal house, the Prussian aristocracy, have then for this bastion towards the east an especial regard, which has not been without its sentimental influence upon the course of the war; and that regard is very highly increased by the artificial political boundaries of modern times.

East Prussia is, for the Germans as a whole, their rampart against the Slav; and though, beyond the present purely political and only century-old frontier, a large Ger-

man-speaking population is to be discovered (especially in the towns under Russian rule), yet such is the influence of a map upon a people essentially bookish in their information, that East Prussia stands to the whole German Empire, as well as to its wealthier inhabitants, for a proof of the German power to withstand the dreaded pressure of the Russian from the East.

It was to be expected, therefore, that two strategical consequences would flow from these non-strategical conditions: first, that the Russians would be tempted—though, no doubt, in very small force for such a secondary operation—to raid a district towards which the enemy's opinion was so sensitive; secondly, that enemy would be tempted, after each such effort, to extend a disproportionate force in ridding the country of such raids.

The Germans, for all the dictates of pure strategics, would hardly hold firm under the news that Slav soldiers were in the farms and country-houses, and were threatening the townfolk of East Prussia. The Russians, though no direct advantage was to be gained, and though the bulk of their force must be used elsewhere, would

certainly be drawn to move into East Prussia in spite of the known and peculiarly heavy difficulties to an advance which that province presented.

What were those difficulties ?

They were of two kinds, the second of which has been, perhaps, unduly emphasized at the expense of the first.

The first was, that the Baltic extreme of this region lay at the very end of the longest possible line the Russians could move on. Even supposing their front extended (as soon it did) from the Carpathians to the sea, this Baltic piece was the end of the line and farthest from their material bases and their sources of equipment. It was badly served with railways, difficult of access from the soil lying to the east, and backed by that sparsely inhabited belt of Russian territory in which the modern capital of St. Petersburg has been artificially erected, but which is eccentric to the vital process of Russia. As a fact, even after eight months of war, let alone in the first phases which we are here about to describe, the extreme end of this line was not attempted by the Russians at all.

Next to this extreme position, which was the first handicap, comes the region of the lakes, the nature of which was the second handicap.

The Masurian Lake district can best be appreciated by some description of its geology and its landscape. It was probably moulded by the work of ice in the past. Great masses of ice have ground out, in their very slow progress towards the sea over the very slight incline northwards of that line, hollows innumerable, and varying from small pools to considerable lakes; the ice has left, upon a background of sand, patches of clay, which hold the waters of all this countryside in brown stretches of shallow mere, and in wider extents of marsh and bog. The rare travellers who explore this confusion of low rounded swells and flats carry back with them to better lands a picture of one grossly monotonous type continuing day upon day. Pine and birch woods, often ordered with the regularity and industry of the German forest organization, but often also straggling and curiously stunted and small, break or confuse the view upon either side.

The impression of the district is most clearly conveyed from some sandy summit, bare of trees, whence a man may overlook, though not from any great height, the desolate landscape for some miles. He obtains from such a view neither the sense of forest which wooded lands of great height convey in spite of their clearings, nor the sense of endless plain which he would find farther to the east or to the north. He perceives through the singularly clear air in autumn brown heaths and plains set here and there with the great stretches of woodland and farmsteads, the stubble of which is soon confused by the eye in the distance with the barren heaths around. In winter, the undulating mass of deep and even snow is marked everywhere by the small, brown, leafless trees in their great groupings, and by the pines, as small, and weighted with the burden of the weather ; but much the most striking of the things seen in such a landscape are the stretches of black water, or, if the season be hard, of black ice which, save when the snow has recently fallen, fierce winds will commonly have swept bare.

The military character of such a region

will be clear. It is, in the technical language of military art, a labyrinth of *defiles*. Care has been expended upon the province, especially in the last two generations, and each narrow passage between the principal sheets of water carries a road, often a hard causeway. A considerable system of railways takes advantage of the same natural narrow issues; but even to those familiar with the country, the complexity of these narrow dry gates or defiles, and their comparative rarity (contrasted with the vast extent of water-logged soil or of open pool), render an advance against any opposition perilous, and even an unopposed advance slow, and dependent upon very careful Staff work. Columns in their progress are for hours out of touch one with the other, and an unexpected check in some one narrow must be met by the force there present alone, for it will not be able to obtain immediate reinforcement.

Again, all this line, with its intermixture of sand and clay, which is due to its geological origin, is a collection of traps for any commander who has not thoroughly studied his lines of advance or of retreat

—one might almost say for any commander who has not had long personal experience of the place. There will be across one mere a belt of sand or gravel, carrying the heaviest burdens through the shallow water as might a causeway. Its neighbour, with a surface precisely twin, with the same brown water, fringed by the same leaves and dreary stretches of stunted wood, will be deep in mud, but a natural platform may stretch into a lake and fail the column which uses it before the farther shore is reached. In the strongest platforms of this kind gaps of deep clay or mud unexpectedly appear. But even with these deceptions, a column is lucky which has only to deal in its march with open water and firm banks; for the whole place is sown with what were formerly the beds of smaller meres, and are now bogs hardened in places, in others still soft—the two types of soil hardly distinguishable.

During any orderly advance, an army proceeding through the Masurian Lakes will strictly confine itself to the great causeways and to the railway. During any retreat in which it is permitted to observe the same order it will be similarly con-

fined to the only possible issues ; but let the retreat be confused, and disaster at once threatens.

A congested column attempting to spread out to the right or to the left will fall into marsh. Guns which it has attempted to save by the crossing of a ford will sooner or later find mud and be abandoned. Men will be drowned in the unexpected deeps, transport embedded and lost ; and apart from all this vast wastage, the confusion of units will speedily put such a brake upon the whole process of retirement that envelopment by an enemy who knows the district more thoroughly is hardly to be avoided.

It was this character in the dreary south of East Prussia which was the cause of Tannenberg, and as we read the strategical plan of that disaster, we must keep in mind the view so presented of an empty land, thus treacherous with marsh and reed and scrub and stretches of barren flat, which may be heath, or may be a horse's height and more of slightly covered slime.

The first phase of the business lasts until the 24th of August, beginning with

the 7th of that month, and may be very briefly dealt with.

Two Russian armies, numbering altogether perhaps 200,000 men, or at the most a quarter of a million, advanced, the one from the Niemen, the other from the Narew—that is, the one from the east, the other from the south, into East Prussia. The Germans had here reserve troops, in what numbers we do not know, but perhaps half the combined numbers of the Russian invasion, or perhaps a little more. The main shock was taken upon the eastern line of invasion at Gumbinnen; the Germans, defeated there, and threatened by the continued advance of the other army to the west of them, which forbade their retreat westward, fell back in considerable disorder upon Königsberg, lost masses of munitions and guns, and were shut up in that fortress. The defeat at Gumbinnen occupied four days—from the 16th to the 20th of August.

Meanwhile the Russian army which was advancing from the Narew had struck a single German army corps—the 20th—in the neighbourhood of Frankenau.

The Russian superiority in numbers was very great ; the German army corps was turned and divided. Half of it fled westward, abandoning many guns and munitions ; the other half fled north-eastward towards Königsberg, and the force as a whole disappeared from the field. The Russians pushed their cavalry westward ; Allenstein was taken, and by the 25th of August the most advanced patrols of the Russians had almost reached the Vistula.

The necessity for retaking East Prussia by the Germans was a purely political one. The vast crowd of refugees flying westward spread panic within the empire. The personal feeling of the Emperor and of the Prussian aristocracy in the matter of the defeated province was keen. Had that attempt to retake East Prussia failed, military history would point to it as a capital example of the error of neglecting purely strategical for political considerations. As a fact, it succeeded beyond all expectation, and its success is known as the German victory of Tannenberg.

The nature of this victory may be grasped from the accompanying sketch map.

From the town of Mława, just within Russian Poland, beyond the frontier, runs, coming up from Warsaw, a railway to Soldau, just upon the Prussian side of the frontier. At Soldau three railways con-

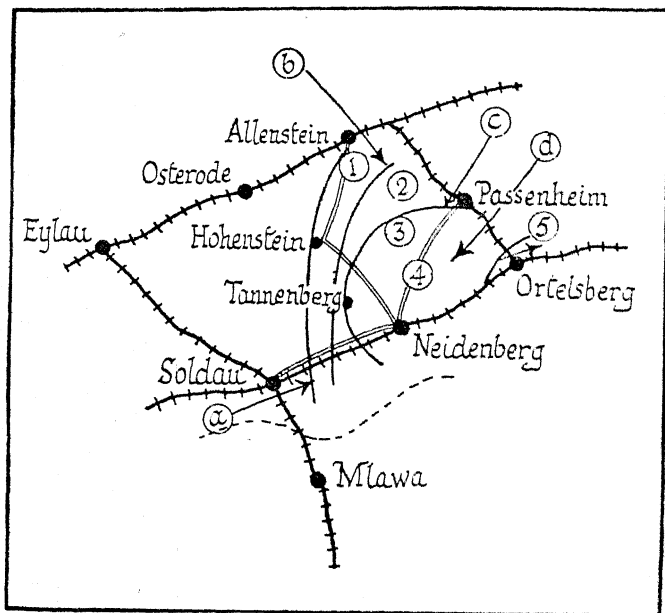

Sketch 73.

verge—one from the east, one going west to Neidenberg and the junction of Ortelsberg, a third coming in from the north-east and Eylau.

From Eylau, through Osterode, the

main international line runs through Allenstein, and so on eastward, while a branch from this goes through Passenheim to the junction at Ortelsberg.

Here, then, you have a quadrilateral of railways about fifty miles in length. Within that quadrilateral is extremely bad country—lakes, marshes, and swamps—and the only good roads within it are those marked in single lines upon my sketch—the road from Allenstein through Hohenstein to Niedenberg, and the road from Niedenberg to Passenheim. As one goes eastwards on that road from Niedenberg to Passenheim, in the triangle Niedenberg-Passenheim-Ortelsberg, the country gets worse and worse, and is a perfect labyrinth of marsh, wood, and swamp. The development of the action in such a ground was as follows:—

The Russian commander, Samsonoff, with his army running from Allenstein southwards, was facing towards the west. He had with him perhaps 200,000 men, perhaps a trifle less. His reconnaissance was faulty, partly because the aeroplanes could discover little in that wooded country, partly because the Staff work was

imperfect, and his Intelligence Department not well informed by his cavalry patrols. He thought he had against him to the west only weak forces. As a fact, the Germans were sending against him what they themselves admit to be 150,000 men, and what were quite possibly nearer 200,000, for they had drawn largely upon the troops within Germany. They had brought round by sea many of the troops shut up in Königsberg, and they had brought up the garrisons upon the Vistula. Further, they possessed, drawn from these garrisons, a great superiority in that arm which throughout all the earlier part of the great war was the German stand-by—heavy artillery, and big howitzers capable of use in the field.

On Wednesday, 26th August, Samsonoff first discovered that he had a formidable force in front of him.

It was under the command of von Hindenburg, a man who had studied this district very thoroughly, and who, apart from his advantage in heavy artillery, knew that difficult country infinitely better than his opponents. During the Wednesday, the 26th, Hindenburg stood upon the

defensive, Samsonoff attacking him upon the line Allenstein-Soldau. At the end of that defensive, the attack on which was badly hampered in so difficult a country, von Hindenburg massed men upon his right near Soldau. This move had two objects: first, by pushing the Russians back there to make them lose the only good road and railway by which they could retire south upon their communications into the country whence they had come; secondly, to make them think, in their natural anxiety for those communications, that his main effort would be delivered there to the south. As a fact, it was his intention to act elsewhere. But the effect of his pressure along the arrow *a* was to give the Russian line by the evening of that Wednesday, the 26th of August, the form of the line *1* upon Sketch 73.

The advantage he had thus gained in front of Soldau, Hindenburg maintained by rapid and successful entrenchment; and the next day, Thursday, 27th August, he moved great numbers round by railway to his left near Allenstein, and appeared there with a great local superiority

in numbers and in heavy guns. By the evening of that day, then, the 27th, he had got the Russian line into the position 2, and the chief effort was being directed along the arrow *b*. On the 28th and 29th the pressure continued, and increased here upon the north; the Russian right was pushed back upon Passenheim, for which there was a most furious fight; and by the evening of the 29th Samsonoff's whole body was bent right round into the curve of the line 3, and vigorous blows were being dealt against it along the arrow *c*, which bent it farther and farther in.

It was clearly evident by that evening, the 29th of August, that Samsonoff must retreat; but his opportunities for such a retreat were already difficult. All he had behind him was the worst piece in the whole country—the triangle Passenheim-Ortelsberg - Niedenberg—and his main avenue of escape was a defile between the lake which the railway at Ortelsberg uses.

His retirement became hopelessly congested. Further pressure along the arrow *d*, during the 30th and 31st, broke that retirement into two halves, one half (as

at 5) making off eastwards, the other half (as at 4) bunched together in a hopeless welter in a country where every egress was blocked by swamp and mire, and subjected to the pounding of the now concentrated ring of heavy guns. The body at 5 got away in the course of the 1st and 2nd of September, but only at the expense of leaving behind them great numbers of guns, wounded, and stragglers. The body at 4 was, in the military sense of the word, "annihilated." It numbered at least two army corps, or 80,000 men, and of these it is probable that 50,000 fell into the hands of the enemy, wounded and unwounded. The remainder, representing the killed, and the chance units that were able to break out, could hardly have been more than 20,000 to 30,000 men.

Such was the victory of Tannenberg.—an immensely successful example of that enveloping movement which the Germans regarded as their peculiar inheritance; a victory in nature recalling Sedan, and upon a scale not inferior to that battle.

The news of that great triumph reached

Berlin upon Sedan Day, at the very moment when the corresponding news from the West was that von Kluck had reached the gates of Paris, and had nothing in front of him but the broken and inferior armies of a disastrous defeat.

THE SPIRITS IN CONFLICT.

At this point it is well to pause and consider an element of the vastest consequence of the whole conduct of these great campaigns—I mean the element of German confidence.

Here we have a nation which has received within a fortnight of its initial large operations, within the first five weeks of a war which it had proudly imposed upon its enemies, the news of a victory more startlingly triumphant than its most extreme expectation of success had yet imagined possible.

Let the reader put himself into the position of a German subject in his own station of life, a town dweller, informed as is the English reader by a daily press, which has come to be his sole source of opinion, enjoying or suffering that almost physical

self-satisfaction and trust in the future which is, unfortunately, not peculiar to the North German, but common in varying degree to a whole school of morals to-day. Let him remember that this man has been specially tutored and coached into a complete faith in the superiority of himself and his kind over the rest of the human race, and this in a degree superior even to that in which other nations, including our own, have indulged after periods of expanding wealth and population.

Let the reader further remember that in this the Germans' rooted faith their army was for them at once its cause and its expression; then only can he conceive what attitude the mind of such men would assume upon the news from East and from West during those days—the news of the avalanche in France and the news of Tannenberg. It would seem to the crowd in Berlin during the great festival which marked the time that they were indeed a part of something not only necessarily invincible, but of a different kind in military superiority from other men.

These, from what would seem every quarter of the globe, had been gathered to

oppose him, merely because the German had challenged his two principal enemies. Though yet far from being imperilled by so universal a movement, he crushes it utterly, and in a less time than it takes for a great nation to realize that it is under arms, he is overwhelmed by the news not of his enemy's defeat, but rather of his annihilation. Miles of captured guns and hour upon hour of marching columns of prisoners are the visible effect of his triumph and the confirmation of it; and he hears, after the awful noise of his victories, a sort of silence throughout the world—a silence of awe and dread, which proclaims him master. It is the anniversary of Sedan.

I do not set down this psychological phenomenon for the mere pleasure of its description, enormous as that phenomenon is, and worthy of description as it is. I set it down because I think that only in an appreciation of it can one understand the future development of the war. After the Battle of Metz, after the sweep down upon Paris from the Sambre, after this immense achievement of Tannenberg, the millioned opinion of a now united North Germany was fixed. It was

so fixed that even a dramatically complete disaster (and the German armies have suffered none) might still leave the North German unshaken in his confidence. Defeats would still seem to him but episodes upon a general background, whose texture was the necessary predominance of his race above the lesser races of the world. This is the mood we shall discover in all that Germany does from that moment forward. It is of the first importance to realize it, because that mood is, so to speak, the chemical basis of all the reactions that follow. That mood, disappointed, breeds fury and confusion; in the event of further slight successes, it breeds a vast exaggeration of such success; in the presence of any real though but local advance, it breeds the illusion of a final victory.

It is impossible to set down adequately in these few pages this intoxication of the first German victories. It must be enough to recall to the reader that the strange mood with which we have to deal was also one of a century's growth, a century during which not only in Germany, but in Scandinavia, in the universities (and many other cliques) of England, even largely in the

United States, a theory had grown and prospered that something called "the Teutonic race" was the origin of all we valued; that another thing, called in one aspect "the Latin" or in another aspect "the Celt," was something in the one case worn out, in the other negligible through folly, instability, and decay. The wildest history gathered round this absurd legend, not only among the Germans but wherever the "Teutonic theory" flourished, and the fatuous vanity of the North German was fed by the ceaseless acceptance of that legend on the part of those who believed themselves to be his kinsmen.

They still believe it. In every day that passes the press of Great Britain reveals the remains of this foolery. And while the real person, England, is at grips with another real thing, Prussia, which is determined to kill her by every means in its power, the empty theorizing of professors who do not see *things*, but only the imaginary figures of their theories, continues to regard England as in some way under a German debt, and subject to the duty of admiring her would-be murderer.

Before leaving this digression, I would

further remind the reader that nowhere in the mass of the British population is this strange theory of German supremacy accepted, and that outside the countries I have named not even the academic classes consider it seriously. In the eyes of the Frenchman, the Italian, and the Pole, the North German is an inferior. His numbers and his equipment for war do not affect that sentiment, for it is recognized that all he has and does are the product of a lesson carefully learned, and that his masters always were and still are the southern and the western nations, with their vastly more creative spirit, their hardier grip in body as in mind, their cleaner souls, and their more varied and developed ideals.

If this was the mood of the German people when the war in its first intense moment had, as it were, cast into a permanent form the molten popular soul, what was that of the nation which the Germans knew in their hearts, in spite of the most pitiable academic illusion, to be the permanent and implacable enemy—I mean the French people?

Comprehend the mood of the French,

contrast and oppose it to that of the Germans, and you will have viewed almost in its entirety the spiritual theatre of this gigantic struggle. No don's talk of "Slav" or "Teuton," of "progressive" or "backward" nations, mirrors in any way the realities of the great business. This war was in some almost final fashion, and upon a scale quite unprecedented, the returning once again of those conflicting spirits which had been seen over the multitudes in the dust of the Rhone valley when Marius came up from Italy and met the chaos in the North. They had met again in the damp forests of the Ardennes and the vague lands beyond the Rhine, when the Roman auxiliaries of the decline pushed out into the Germanies to set back the frontiers of barbarism. It was the clash between strong continuity, multiple energies, a lucid possession of the real world, a creative proportion in all things—all that we call the ancient civilization of Europe—and the unstable, quickly growing, quickly dissolving outer mass which continually learns its lesson from the civilized man, and yet can never perfectly learn that

lesson ; which sees itself in visions and has dreams of itself : which now servilely accepts the profound religion of its superior ; now, the brain fatigued by mysteries, shakes off that burden which it cannot comprehend.

By an accident comparatively recent, the protagonist of chaos in these things happened to be that rigid but curiously amorphous power which Prussia has wielded for many years to no defined end. The protagonist upon the other side of the arena was that same Romanized Gaul which had ever since the fall of the Empire least lost the continuity with the past whereby we live.

But the defender of ancient things was (again by an accident in what is but a moment for universal history) the weaker power. In the tremendous issue it looked as though numbers and values had fallen apart, and as though the forces of barbarism, though they could never make, would now at last permanently destroy.

In what mood, I say, did the defenders of the European story enter the last and most perilous of their debates ? We must be able to answer that question if we are to

understand even during the course of the war its tendency and its probable end.

By the same road, the valley of the Oise, which had seen twenty times before lesser challenges of the kind, the North had rushed down. It was a gauge of its power that all the West was gathered there in common, with contingents from Britain in the heart of the press.

The enemy had come on in a flood of numbers: the defence, and half as much as the defence, and more again. The line swung down irresistible, with the massy weight of its club aimed at Paris. If the eastern forts at Toul and at Verdun and the resistance before Nancy had held back its handle, that resistance had but enabled it to pivot with the freer swing. Not only had there fallen back before its charge all the arrayed armies of the French and their new Ally, but also all that had counted in the hopes of the defenders had failed. All that the last few years had promised in the new work of the air, all that a generation had built up of permanent fortified work, had been proved impotent before the new siege train. The

barrier fortresses of the Meuse, Liège and Namur, had gone up like paper in a fire. Maubeuge was at its last days. Another week's bombardment and the ring of Verdun would be broken.

The sweep has no parallel in the monstrous things of history. Ten days had sufficed for the march upon the capital. Nor had there been in that ten days a moment's hope or an hour of relaxation.

No such strain has yet been endured, so concentrated, so exact an image of doom.

And all along the belt of that march the things that were the sacrament of civilization had gone. Rheims was possessed, the village churches of the "Island of France" and of Artois were ruins or desolations. The peasantry already knew the destruction of something more than such material things, the end of a certain social pact which war in Christendom had spared. They had been massacred in droves, with no purpose save that of terror; they had been netted in droves, the little children and the women with the men, into captivity. The track of

the invasion was a wound struck not, as other invasions have been, at some territory or some dynasty; it was a wound right home to the heart of whatever is the West, of whatever has made our letters and our buildings and our humour between them. There was a death and an ending in it which promised no kind of reconstruction, and the fools who had wasted words for now fifty years upon some imagined excellence in the things exterior to the tradition of Europe, were dumb and appalled at the sight of barbarism in action—in its last action after the divisions of Europe had permitted its meaningless triumph for so long. Were Paris entered, whether immediately or after that approaching envelopment of the armies, it would be for destruction; and all that is not replaceable in man's work would be lost to our children at the hands of men who cannot make.

The immediate approach of this death and the cold wind of it face to face produced in the French people a singular reaction, which even now, after eight months of war, is grimly seen. Their irony was resolved into a strained silence.

Their expectation was halted and put aside. They prophesied no future; they supported the soul neither with illusions nor with mere restraint; but they threw their whole being into a tension like that of the muscles of a man's face when it is necessary for him to pass and to support some overmastering moment. There was no will at issue with the small group of united wills whose place was at the headship of the army. The folly of the politicians had not only ceased, but had fallen out of memory.

It is no exaggeration to say that the vividness of that self-possession for a spring annihilated time. It was not a fortnight since the blow had come of the 15th Corps breaking before Metz, and the stunning fall of Namur. But to the mind of the People it was already a hundred years, and conversely the days that passed did not pass in hours, or with any progression, but stood still.

There was to come—it was already in the agony of birth—the moment, a day and a night, in which one effort rolled the wave right back. That effort did not release the springs of the national soul.

They remained stretched to the utmost. By a character surely peculiar to this unexampled test of fire, no relaxation came as, month after month, the war proceeded.

But the passage of so many days, with the gradual broadening of vision and, in time, the aspect, though distant, of slow victory; the creeping domination acquired over the mass of spiritually sodden things that had all but drowned the race; the pressure of the hand tightening upon the throat of the murderer; released a certain high potential which those who do not know it can no more comprehend than a savage can comprehend the lightning which civilized man regulates and holds in the electric wire. And this potential made, and is making, for an intense revenge.

That is the vision that should remain with those who desire to understand the future the war must breed, and that is the white heat of energy which will explain very terrible things, still masked by the future, and undreamt of here.